

# Essentials

ACCESSORIES & MORE



# Essentials

accessories & more



# INDICE

INDEX



**p. 5**

## **SPECCHIERE E FARETTI**

MIRRORS AND  
SPOTLIGHTS

MIROIRS  
ET SPOTS



**p. 47**

## **RUBINETTI E LAVABI**

WASHBASIN MIXERS  
AND WASHBASINS

MITIGEURS LAVABO  
ET LAVABOS



**p. 89**

## **CONSOLLE**

CONSOLE  
CONSOLE



**p. 123**

## **PIANI CON LAVABI INTEGRATI**

TOPS WITH BUILT-IN  
WASHBASINS

PLANS AVEC LAVABOS  
INTEGRÉES



**p. 153**

## **ACCESSORI**

ACCESSORIES  
ACCESSOIRES



**p. 175**

## **VASCHE DA BAGNO**

BATHTUBS  
BAGNOIRES

ALMOND  
CON FARETTO ELLIPSE MAXI



01.

# **SPECCHIERE E FARETTI**

---

MIRRORS AND SPOTLIGHTS  
MIROIRS ET SPOTS

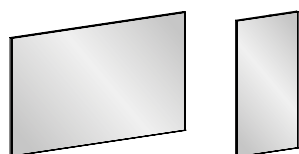

## LESS

**Specchiera Less con profilo finitura alluminio  
Senza interruttore  
Senza faretto di serie (è possibile installare faretti)**

Less mirror with aluminium finish frame  
Without switch  
Without spotlight as standard (spotlights can be installed)

Miroir Less avec profilé en aluminium  
Sans interrupteur  
Sans spot (il est possible d'ajouter des spots)

**Spessore / Thickness / Épaisseur: 2,7 cm**

**Misure disponibili (LxH) / Dimensions (WxH) / Mesures (LxH)**

- > Art. **S733** 50 x 73,4
- > Art. **S734** 60 x 73,4
- > Art. **S735** 70 x 73,4
- > Art. **S736** 85 x 73,4
- > Art. **S737** 95 x 73,4
- > Art. **S738** 105 x 73,4
- > Art. **S739** 120 x 73,4
- > Art. **S740** 140 x 73,4
- > Art. **S741** 49 x 95
  
- > Art. **SF MJ** Fuori misura (max L 210 x H 120 cm)  
Out of standard (max W 210 x H 120 cm)  
Hors mesure (max L 210 x H 120 cm)

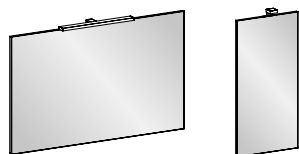

## LIGHT

**Specchiera Light con profilo in alluminio Brill  
> ORIZZONTALE con faretto centrale Miky New led (art. V631)  
> VERTICALE con faretto centrale Thunder led (art. V832)**

Light mirror with Brill aluminium frame  
> HORIZONTAL with standard spotlight MIKY NEW (V931)  
> VERTICAL with standard spotlight THUNDER (V832)

Miroir LIGHT avec profil en aluminium Brill  
> HORIZONTAL avec spot MIKY NEW (V931) de série  
> VERTICAL with standard spotlight THUNDER (V832)

**Spessore / Thickness / Épaisseur: 2,7 cm**

**Misure disponibili (LxH) / Dimensions (WxH) / Mesures (LxH)**

- |                               |                               |
|-------------------------------|-------------------------------|
| > Art. <b>S937</b> 60 x 49    | > Art. <b>S938</b> 60 x 73,4  |
| > Art. <b>S940</b> 70 x 49    | > Art. <b>S941</b> 70 x 73,4  |
| > Art. <b>S943</b> 85 x 49    | > Art. <b>S944</b> 85 x 73,4  |
| > Art. <b>S946</b> 95 x 49    | > Art. <b>S947</b> 95 x 73,4  |
| > Art. <b>S949</b> 105 x 49   | > Art. <b>S950</b> 105 x 73,4 |
| > Art. <b>S952</b> 120 x 49   | > Art. <b>S953</b> 120 x 73,4 |
| > Art. <b>S955</b> 130 x 49   | > Art. <b>S956</b> 130 x 73,4 |
| > Art. <b>S958</b> 140 x 49   | > Art. <b>S959</b> 140 x 73,4 |
| > Art. <b>S260</b> 60 x 61,2  | > Art. <b>S960</b> 36,8 x 95  |
| > Art. <b>S261</b> 70 x 61,2  | > Art. <b>S961</b> 49 x 95    |
| > Art. <b>S262</b> 85 x 61,2  | > Art. <b>S962</b> 55,4 x 95  |
| > Art. <b>S263</b> 95 x 61,2  |                               |
| > Art. <b>S264</b> 105 x 61,2 |                               |
| > Art. <b>S265</b> 120 x 61,2 |                               |
| > Art. <b>S266</b> 130 x 61,2 |                               |
| > Art. <b>S267</b> 140 x 61,2 |                               |

- > Art. **SF ML** Fuori misura (max L 210 x H 120 cm)  
Out of standard (max W 210 x H 120 cm)  
Hors mesure (max L 210 x H 120 cm)

### FINITURE / FINISHES / FINITIONS

Di serie  
As standard  
De série



Fuori misura  
Out of standard  
Hors mesure

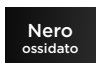

LIGHT Nero  
con faretto Laser Nero



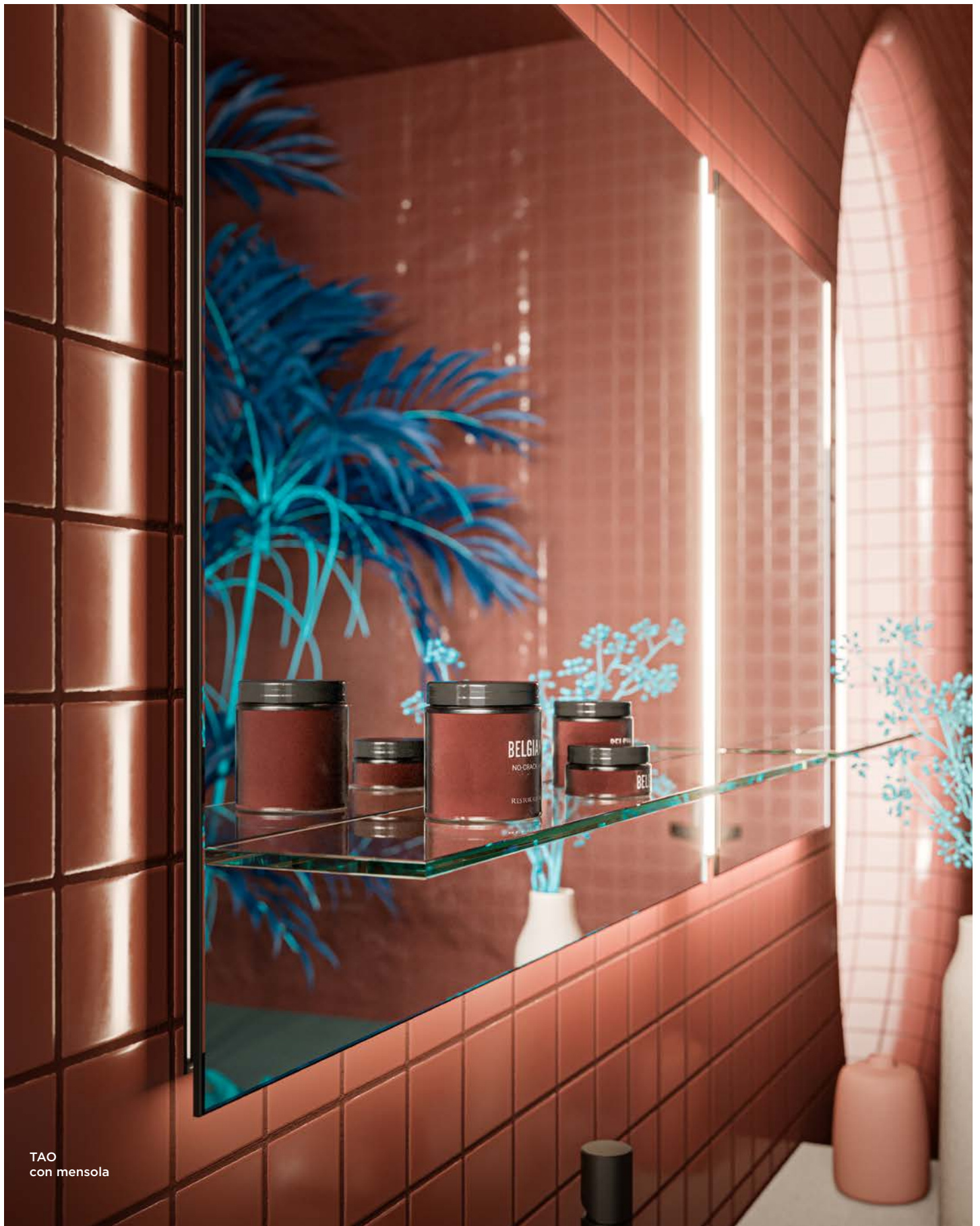

TAO  
con mensola

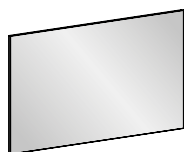

## TAO

**Specchiera Tao con profilo in alluminio e luce Led perimetrale 4000 K di serie (3000 K su richiesta). Senza interruttore.**

Tao mirror with aluminium frame and 4000 K perimeter led light as standard (3000 K on request). Without switch.

Miroir Tao avec profilé en aluminium et éclairage LED périmètre 4000 K de série (3000 K sur demande). Sans interrupteur.

**Spessore / Thickness / Épaisseur: 2,5 cm**

**Misure disponibili (LxH) / Dimensions (WxH) / Mesures (LxH)**

- |                    |            |                    |            |
|--------------------|------------|--------------------|------------|
| > Art. <b>S751</b> | 60 x 61,2  | > Art. <b>S752</b> | 60 x 73,4  |
| > Art. <b>S753</b> | 70 x 61,2  | > Art. <b>S754</b> | 70 x 73,4  |
| > Art. <b>S755</b> | 85 x 61,2  | > Art. <b>S756</b> | 85 x 73,4  |
| > Art. <b>S757</b> | 95 x 61,2  | > Art. <b>S758</b> | 95 x 73,4  |
| > Art. <b>S759</b> | 105 x 61,2 | > Art. <b>S760</b> | 105 x 73,4 |
| > Art. <b>S761</b> | 120 x 61,2 | > Art. <b>S762</b> | 120 x 73,4 |
| > Art. <b>S763</b> | 130 x 61,2 | > Art. <b>S764</b> | 130 x 73,4 |
| > Art. <b>S765</b> | 140 x 61,2 | > Art. <b>S766</b> | 140 x 73,4 |
- > Art. **SFMT** Fuori misura (max L 210 x H 120 cm)  
Out of standard (max W 210 x H 120 cm)  
Hors mesure (max L 210 x H 120 cm)

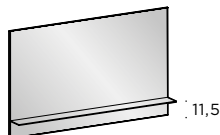
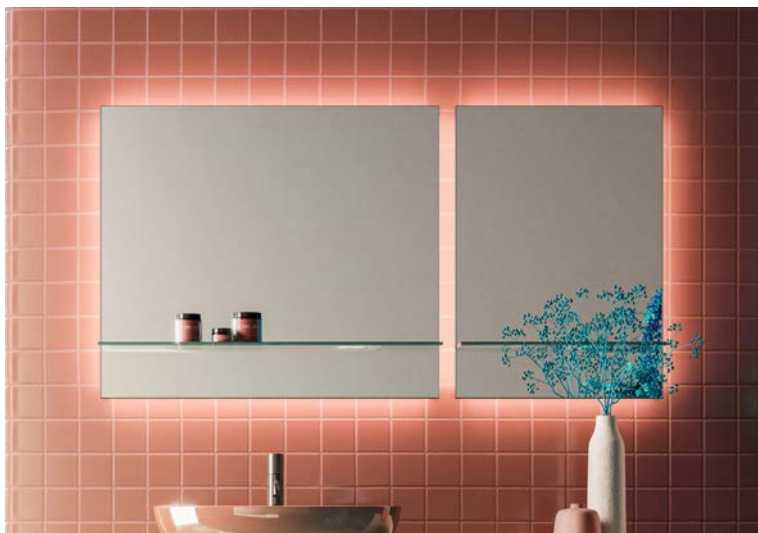

## TAO con mensola

**Specchiera Tao con mensola in vetro sp. 6 mm. Profilo in alluminio e luce Led perimetrale 4000 K di serie (3000 K su richiesta). Senza interruttore**

Tao mirror with glass shelf th. 6 mm. Aluminium frame and 4000 K perimeter led light as standard (3000 K on request). Without switch.

Miroir Tao avec étagère en verre ép. 6 mm. Profilé en aluminium et éclairage LED périmètre 4000 K de série (3000 K sur demande). Sans interrupteur.

**Spessore / Thickness / Épaisseur: 2,5 + 11,3 cm**

**Misure disponibili (LxH) / Dimensions (WxH) / Mesures (LxH)**

- |                    |            |
|--------------------|------------|
| > Art. <b>X03R</b> | 60 x 73,4  |
| > Art. <b>X03S</b> | 70 x 73,4  |
| > Art. <b>X03T</b> | 85 x 73,4  |
| > Art. <b>X03U</b> | 95 x 73,4  |
| > Art. <b>X03V</b> | 105 x 73,4 |
| > Art. <b>X03W</b> | 120 x 73,4 |
| > Art. <b>X03X</b> | 130 x 73,4 |
| > Art. <b>X03Y</b> | 140 x 73,4 |
- > Art. **XF3L** Fuori misura (max L 210 x H 120 cm)  
Out of standard (max W 210 x H 120 cm)  
Hors mesure (max L 210 x H 120 cm)



## AJOUR

Specchiera Ajour con profilo in alluminio Brill, serigrafia perimetrale frontale H 5 cm. Retroilluminazione LED 4000 K (3000 K su richiesta). Senza interruttore.

AJOUR mirror with Brill finish aluminium frame, fronte perimetral screen-printing H 5 cm. 4000K led backlighting (3000 K on request). Without switch.

Miroir AJOUR avec profil en aluminium Brill, avec sérigraphie périmétrale frontale H 5 cm. Rétro-éclairée à led 4000K (3000 K sur demande). Sans interrupteur.

Spessore / Thickness / Épaisseur: **4 cm**

Misure disponibili (LxH) / Dimensions (WxH) / Mesures (LxH)

- |                    |            |                    |            |
|--------------------|------------|--------------------|------------|
| > Art. <b>SA01</b> | 60 x 61,2  | > Art. <b>SA02</b> | 60 x 73,4  |
| > Art. <b>SA03</b> | 70 x 61,2  | > Art. <b>SA04</b> | 70 x 73,4  |
| > Art. <b>SA05</b> | 85 x 61,2  | > Art. <b>SA06</b> | 85 x 73,4  |
| > Art. <b>SA07</b> | 95 x 61,2  | > Art. <b>SA08</b> | 95 x 73,4  |
| > Art. <b>SA09</b> | 105 x 61,2 | > Art. <b>SA10</b> | 105 x 73,4 |
| > Art. <b>SA11</b> | 120 x 61,2 | > Art. <b>SA12</b> | 120 x 73,4 |
| > Art. <b>SA13</b> | 130 x 61,2 | > Art. <b>SA14</b> | 130 x 73,4 |
| > Art. <b>SA15</b> | 140 x 61,2 | > Art. <b>SA16</b> | 140 x 73,4 |
- > Art. **SFMA** Fuori misura (max L 210 x H 120 cm)  
Out of standard (max W 210 x H 120 cm)  
Hors mesure (max L 210 x H 120 cm)

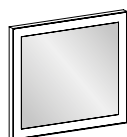

### FINITURE / FINISHES / FINITIONS

Di serie  
As standard  
De série

Brill

Fuori misura  
Out of standard  
Hors mesure

Bianco  
opaco



## HIDE

Specchiera Hide con profilo in alluminio (2 cm). Luce Led 4000 K perimetrale interna di serie (3000 K su richiesta). Senza interruttore.

HIDE mirror with aluminium frame (2 cm). 4000 K perimeter led light inside as standard (3000 K on request). Without switch.

Miroir HIDE avec profil en aluminium (2 cm). Avec Led 4000 K périmétral interne de série (3000 K sur demande). Sans interrupteur.

Spessore / Thickness / Épaisseur: **5,3 cm**

Misure disponibili (LxH) / Dimensions (WxH) / Mesures (LxH)

- |                    |            |                    |            |
|--------------------|------------|--------------------|------------|
| > Art. <b>S888</b> | 60 x 61,2  | > Art. <b>S592</b> | 60 x 73,4  |
| > Art. <b>S889</b> | 70 x 61,2  | > Art. <b>S593</b> | 70 x 73,4  |
| > Art. <b>S890</b> | 85 x 61,2  | > Art. <b>S594</b> | 85 x 73,4  |
| > Art. <b>S891</b> | 95 x 61,2  | > Art. <b>S595</b> | 95 x 73,4  |
| > Art. <b>S892</b> | 105 x 61,2 | > Art. <b>S596</b> | 105 x 73,4 |
| > Art. <b>S893</b> | 120 x 61,2 | > Art. <b>S597</b> | 120 x 73,4 |
| > Art. <b>S894</b> | 130 x 61,2 | > Art. <b>S598</b> | 130 x 73,4 |
| > Art. <b>S895</b> | 140 x 61,2 | > Art. <b>S599</b> | 140 x 73,4 |
- > Art. **SFMH** Fuori misura (max L 210 x H 120 cm)  
Out of standard (max W 210 x H 120 cm)  
Hors mesure (max L 210 x H 120 cm)

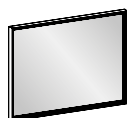

### FINITURE / FINISHES / FINITIONS

Bianco  
opaco

Nero  
ossidato

Rodio  
lucido

Inox  
spazzolato

Oro  
spazzolato

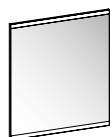

## KREA

Specchiera Krea H 73,4 con profilo in alluminio.  
Luce LED 4000 K di serie (3000 K su richiesta) sulle due fasce satiniate H 3,5 cm sopra e sotto. Interruttore a destra di serie.

Krea H 73.4 mirror with aluminium profile.  
4000 K LED light (3000 K on request) on the two satin-finish strips H 3.5 cm above and below. Switch on the right as standard.

Miroir Krea H 73,4 avec profilé en aluminium.  
Éclairage LED 4000 K (3000 K sur demande) sur les deux bandes satinées H 3,5 cm en haut et en bas.  
Interruteur à droite de série.

Spessore / Thickness / Épaisseur: **2,6 cm**

Misure disponibili (LxH) / Dimensions (WxH) / Mesures (LxH)

- > Art. **S487** 60 x 73,4
- > Art. **S488** 70 x 73,4
- > Art. **S489** 85 x 73,4
- > Art. **S490** 95 x 73,4
- > Art. **S491** 105 x 73,4
- > Art. **S492** 120 x 73,4
- > Art. **S493** 130 x 73,4
- > Art. **S494** 140 x 73,4
- > Art. **SFMK** Fuori misura solo in larghezza  
Out of size only in width  
Hors mesure uniquement en largeur

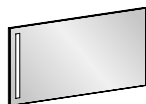
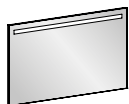

FINITURE / FINISHES / FINITIONS



Brill

## SCIA

Specchiera Scia con profilo rivestito alluminio e fascia satinata H 3,5 cm. Retroilluminazione LED 4000 K (3000 K su richiesta).  
> ORIZZONTALE: serigrafia a sinistra, interruttore sotto.  
> VERTICALE: serigrafia in alto, interruttore a destra.

SCIA mirror with aluminium coated frame and satin-finished strip, H. 3.5 cm. 4000 K led backlighting (3000 K on request).  
> HORIZONTAL: screen-printed on the right, switch on the bottom.  
> VERTICAL: screen-printed on the top, switch on the right.

Miroir SCIA avec profil revêtu en aluminium et bande satinée H 3,5. Rétro-éclairé à led 4000K (3000 K sur demande).  
> HORIZONTAL: Sérigraphie à droite, interrupteur en bas.  
> VERTICAL: Sérigraphie en haut, interrupteur à droite.

Spessore / Thickness / Épaisseur: **3 cm**

Misure disponibili (LxH) / Dimensions (WxH) / Mesures (LxH)

- |                               |                               |
|-------------------------------|-------------------------------|
| > Art. <b>S901</b> 95 x 61,2  | > Art. <b>S907</b> 95 x 61,2  |
| > Art. <b>S903</b> 105 x 61,2 | > Art. <b>S909</b> 105 x 61,2 |
| > Art. <b>S905</b> 120 x 61,2 | > Art. <b>S911</b> 120 x 61,2 |
| > Art. <b>S902</b> 95 x 73,4  | > Art. <b>S908</b> 95 x 73,4  |
| > Art. <b>S904</b> 105 x 73,4 | > Art. <b>S910</b> 105 x 73,4 |
| > Art. <b>S906</b> 120 x 73,4 | > Art. <b>S912</b> 120 x 73,4 |



## BOHEME

Specchiera Boheme con profilo in alluminio, led 4000 K sotto e sopra (3000 K su richiesta). Senza interruttore. Non è possibile aggiungere faretti.

Boheme mirror with aluminium frame, 4000 K LED above and below (3000 K on request). Without switch. No spotlight available for this mirror.

Miroir Boheme avec profilé en aluminium, LED 4000 K en haut et en bas (3000 K sur demande). Sans interrupteur. Il n'est pas possible d'ajouter des spots.

Spessore / Thickness / Épaisseur: **3,9 cm**

Misure disponibili (LxH) / Dimensions (WxH) / Mesures (LxH)

> Art. <b>S973</b>	60 x 61,2	> Art. <b>S981</b>	60 x 73,4
> Art. <b>S974</b>	70 x 61,2	> Art. <b>S982</b>	70 x 73,4
> Art. <b>S975</b>	85 x 61,2	> Art. <b>S983</b>	85 x 73,4
> Art. <b>S976</b>	95 x 61,2	> Art. <b>S984</b>	95 x 73,4
> Art. <b>S977</b>	105 x 61,2	> Art. <b>S985</b>	105 x 73,4
> Art. <b>S978</b>	120 x 61,2	> Art. <b>S986</b>	120 x 73,4
> Art. <b>S979</b>	130 x 61,2	> Art. <b>S987</b>	130 x 73,4
> Art. <b>S980</b>	140 x 61,2	> Art. <b>S988</b>	140 x 73,4

> Art. **SFMO** Fuori misura (max L 210 x H 120 cm)  
Out of standard (max W 210 x H 120 cm)  
Hors mesure (max L 210 x H 120 cm)

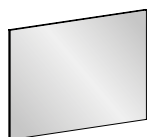

FINITURE / FINISHES / FINITIONS

Bianco  
opaco

Nero  
ossidato

Rodio  
lucido

Inox  
spazzolato



Alla specchiera Boheme è possibile aggiungere la mensola Boheme in alluminio L 35, 50 o 70 cm.

The Boheme aluminium shelf can be added to the Boheme mirror in the following sizes: W 35, 50 or 70 cm.

Au miroir Boheme il est possible d'ajouter l'étagère Boheme en aluminium L 35, 50 ou 70 cm.





## FRAME

Specchiera Frame con sabbiatura circolare/ovale retroilluminata a luce led 3000 K e led perimetrale 3000 K. Senza interruttore.

Frame mirror with circular/oval sandblasting, backlit with 3000K LED lighting and 3000K perimeter LED lighting. Without switch.

Miroir encadrés avec sablage circulaire/ovale, rétroéclairés par un éclairage LED 3000K et un éclairage LED périphérique 3000K. Sans interrupteur.

Spessore / Thickness / Épaisseur: **4,5 cm**

Misure disponibili (LxH) / Dimensions (WxH) / Mesures (LxH)

- > Art. **X03O** 70 x 73,4
- > Art. **X03P** 120 x 73,4
- > Art. **X03Q** 140 x 73,4

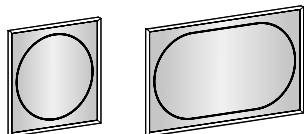

### FINITURE / FINISHES / FINITIONS

Di serie  
As standard  
De série

**Nero**

Varianti  
Variants  
Variantes

**Inox**  
spazzolato

**Oro**  
spazzolato



## DAVE

Specchiera Dave con profilo in acciaio lucido. Barra led 4000 K (sp. 1 cm) in metacrilato, 230 V, 14.4 Watt. Senza interruttore. Non è possibile aggiungere faretti.

DAVE mirror with glossy steel frame. 4000 K led light in methacrylate, 230 V, 14.4 Watt. Without switch. No spotlight available for this mirror.

Miroir DAVE avec profil en acier brillant. Barre led 4000 K en méthacrylate, 230 V, 14.4 Watt. Sans interrupteur. Il n'est pas possible d'ajouter des spots.

Spessore / Thickness / Épaisseur: **2,7 - 5 cm**

Misure disponibili (LxH) / Dimensions (WxH) / Mesures (LxH)

- > Art. **S644** 70 x 73,4
- > Art. **S645** 85 x 73,4
- > Art. **S646** 95 x 73,4
- > Art. **S647** 105 x 73,4
- > Art. **S648** 120 x 73,4
- > Art. **S649** 140 x 73,4

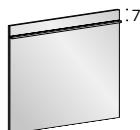

### FINITURE / FINISHES / FINITIONS

**Acciaio**  
lucido



## DEMILUNE

Specchiera Demilune dx-sx. Senza interruttore.  
Luce Led perimetrale 4000 K disponibile con maggiorazione (3000 K su richiesta). Specificare il verso dello specchio al momento dell'ordine.

Demilune right-left mirror. Without switch.  
4000 K perimeter LED lighting available with surcharge (3000 K on request). Always specify the direction of the mirror when ordering.

Miroir Demilune droite-gauche. Sans interrupteur.  
Éclairage LED 4000 K périphérique disponible avec supplément (3000 K sur demande). Toujours préciser le sens du miroir lors de la commande.

Spessore / Thickness / Épaisseur: **2,2 cm**

Misure disponibili (LxH) / Dimensions (WxH) / Mesures (LxH)

> Art. **X03M** 88,5 x 200

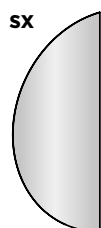

## LIGHT TONDA

Specchiera LIGHT TONDA con faretto THUNDER led di serie.  
Luce Led perimetrale 4000 K disponibile con maggiorazione (3000 K su richiesta).

LIGHT TONDA mirror with THUNDER led spotlight as standard.  
4000 K perimeter LED lighting available with surcharge (3000 K on request).

Miroir LIGHT TONDA avec spot THUNDER led de série.  
Éclairage LED 4000 K périphérique disponible avec supplément (3000 K sur demande).

Spessore / Thickness / Épaisseur: **2,2 cm**

Misure disponibili / Dimensions / Mesures

- > Art. **S268** Ø 30\*
- > Art. **S269** Ø 40\*
- > Art. **S113** Ø 68
- > Art. **S112** Ø 85
- > Art. **S278** Ø 100
- > Art. **S708** Ø 120
- > Art. **S709** Ø 130
- > Art. **S710** Ø 140
- > Art. **S716** Ø 160\*

\* misure Ø 30, 40 e 160 senza faretto di serie  
sizes Ø 30, 40 e 160 without standard spotlight  
mesures Ø 30, 40 e 160 sans spot standard

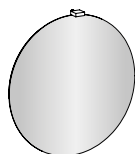

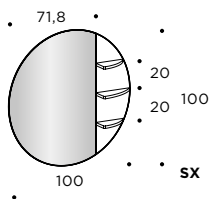

**FINITURE / FINISHES / FINITIONS**



**Colori Arbi**  
Arbi Colours  
Couleurs Arbi

# GIOTTO

**Specchiera Giotto dx-sx**  
Specchio con pannello laccato colore opaco o metal con 3 mensole curve sp. 1,8 x P 12 cm. Senza interruttore.  
Luce Led perimetrale 4000 K disponibile con maggiorazione (3000 K su richiesta). Specificare sempre il verso dello specchio e il colore del pannello al momento dell'ordine.

Giotto right-left mirror.  
Mirror with matt or metallic lacquered panel with 3 curved shelves, thickness 1.8 cm, depth 12 cm. Without switch.  
4000 K perimeter LED lighting available with surcharge (3000 K on request). Always specify the direction of the mirror and the colour of the panel when ordering.

Miroir Giotto droite-gauche.  
Miroir avec panneau laqué mat ou métallisé avec 3 étagères incurvées, épaisseur 1,8 cm, profondeur 12 cm. Sans interrupteur.  
Éclairage LED 4000 K périphérique disponible avec supplément (3000 K sur demande). Précisez toujours l'orientation du miroir et la couleur du panneau lors de la commande.

**Spessore / Thickness / Épaisseur: 2,2 - 14,2 cm**

**Misure disponibili (LxH) / Dimensions (WxH) / Mesures (LxH)**  
> Art. **X001** Ø 100





## SUNSET

**Specchiera Sunset. Senza interruttore.  
Luce Led perimetrale 4000 K disponibile con maggiorazione  
(3000 K su richiesta).**

Sunset mirror. Without switch.  
4000 K perimeter LED lighting available with surcharge (3000 K on request).

Miroir Sunset. Sans interrupteur.  
Éclairage LED 4000 K périphérique disponible avec supplément  
(3000 K sur demande).

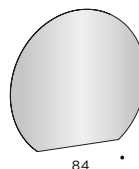

**Spessore / Thickness / Épaisseur: 2,2 cm**

**Misure disponibili (LxH) / Dimensions  
(WxH) / Mesures (LxH)**

> Art. **S586** 140 x 126



## AURA

**Specchiera Aura con serigrafia satinata 3 cm e luce led 4000 K  
perimetrale interna.  
Interruttore touch dimmerabile.**

AURA mirror with silkscreen-printing 3 cm and 4000 K internal  
perimeter led light.  
Dimmable touch switch.

Miroir AURA avec sérigraphie satinée 3 cm et éclairage à led  
4000 K périmétral interne.  
Interrupteur tactile dimmable.

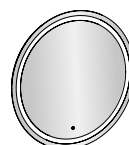

**Spessore / Thickness / Épaisseur: 2,2 cm**

**Misure disponibili (LxH) /  
Dimensions (WxH) / Mesures (LxH)**

> Art. **S588** Ø 85



## PENDANT

**Specchiera Pendant con telaio in lamiera nera, cinghia in  
ecopelle nera con supporto metallico nero. Senza interruttore**

Pendant mirrors with black sheet metal frame, black faux leather  
strap with black metal support. Without switch.

Miroirs suspendus avec cadre en tôle noire, sangle en simili cuir  
noir avec support métallique noir. Sans interrupteur.

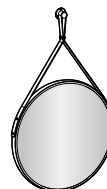

**Spessore / Thickness / Épaisseur: 3,5 cm**

**Misure disponibili / Dimensions / Mesures**

> Art. **X042** Ø 60,3 - H 99

> Art. **X041** Ø 80,5 - H 114,6

SUNSET





## PITAGORA

Specchiere Pitagora con sabbiatura quadrata retroilluminata a luce led 3000 K. Luce led 3000 K perimetrale. Senza interruttore.

Pitagora mirrors with square sandblasted finish 3000 K LED backlighting. 3000 K LED perimeter lighting. No switch.

Miroirs Pitagora avec sablage carré rétroéclairés par une lumière LED 3000K. Lumière LED 3000K sur le pourtour. Sans interrupteur.

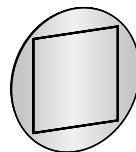

Spessore / Thickness / Épaisseur: **3 cm**

Misure disponibili / Dimensions / Mesures

- > Art. **X004** Ø 70 - LED 45x45
- > Art. **X003** Ø 85 - LED 55x55
- > Art. **X005** Ø 100 - LED 66x66



## COMPASS

Specchiera Compass con bisello 1 cm, luce led perimetrale continua 4000 k di serie. Accensione/spegnimento con interruttore touch. Dimmerabile..

COMPASS mirror with 1 cm bevelled edge, continuous perimeter led light 4000 K as standard. Touch ON/OFF switch. Dimmable

Miroir COMPASS avec biseau de 1 cm éclairage à led périmétral continu 4000 K de série. Allumage/extinction avec touch. Dimmable.

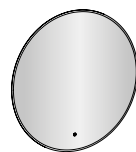

Spessore / Thickness / Épaisseur: **2,2 cm**

Misure disponibili / Dimensions / Mesures

- > Art. **S247** Ø 85
- > Art. **S249** Ø 100
- > Art. **S251** Ø 120



## PANDORA

Specchiera Pandora con bisello 1 cm, luce led perimetrale continua 4000 k di serie. Accensione/spegnimento con interruttore touch.

PANDORA mirror with 1 cm bevelled edge, continuous perimeter led light 4000 K as standard. Touch ON/OFF switch.

Miroir PANDORA avec biseau de 1 cm éclairage à led périmétral continu 4000 K de série. Allumage/extinction avec touch.



Spessore / Thickness / Épaisseur: **2,2 cm**

Misure disponibili (LxH) / Dimensions (WxH) / Mesures (LxH)

- > Art. **S470** 50 x 110

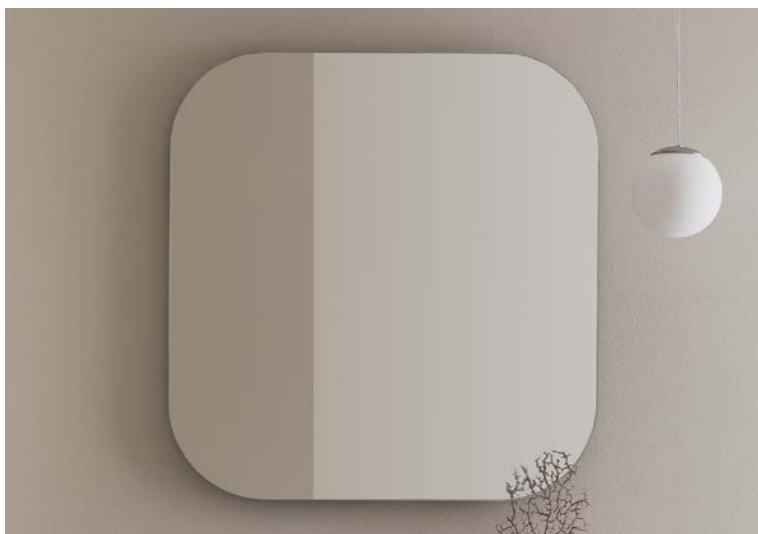

## JOLIE

**Specchiera Jolie. Senza interruttore. Luce Led perimetrale 4000 K disponibile con maggiorazione (3000 K su richiesta).**

Jolie mirror. Without switch. 4000 K perimeter LED lighting available with surcharge (3000 K on request).

Miroir Jolie. Sans interrupteur. Éclairage LED 4000 K périphérique disponible avec supplément (3000 K sur demande).



**Spessore / Thickness / Épaisseur: 2,2 cm**

**Misure disponibili (LxH) /**  
Dimensions (WxH) / Mesures (LxH)

> Art. **S458** 70 x 73,4



## OLIVIA

**Specchiera Olivia. Senza interruttore. Luce Led perimetrale 4000 K disponibile con maggiorazione (3000 K su richiesta).**

Olivia mirror. Without switch. 4000 K perimeter LED lighting available with surcharge (3000 K on request).

Miroir Olivia. Sans interrupteur. Éclairage LED 4000 K périphérique disponible avec supplément (3000 K sur demande).



**Spessore / Thickness / Épaisseur: 2,2 cm**

**Misure disponibili (LxH) /**  
Dimensions (WxH) / Mesures (LxH)

> Art. **S459** 50 x 100



## LORD

**Specchiera Lord. Senza interruttore. Luce Led perimetrale 4000 K disponibile con maggiorazione (3000 K su richiesta).**

Lord mirror. Without switch. 4000 K perimeter LED lighting available with surcharge (3000 K on request).

Miroir Lord. Sans interrupteur. Éclairage LED 4000 K périphérique disponible avec supplément (3000 K sur demande).

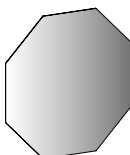

**Spessore / Thickness / Épaisseur: 2,2 cm**

**Misure disponibili (LxH) /**  
Dimensions (WxH) / Mesures (LxH)

> Art. **S457** 85 x 85

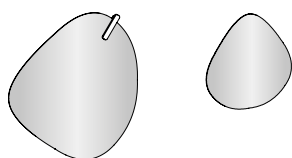

## FANCY

**Specchiere Fancy. Luce Led perimetrale 4000 K disponibile con maggiorazione (3000 K su richiesta).**  
> FANCY 80: faretto On di serie (art. V054) senza interruttore;  
> FANCY 40: senza faretto e senza interruttore.

Fancy mirror. 4000 K perimeter LED lighting available with surcharge (3000 K on request).  
> FANCY 80 with standard spotlight ON (art. V054)  
> Fancy 40 without spotlight.

Fancy Olivia. Éclairage LED 4000 K périphérique disponible avec supplément (3000 K sur demande).  
> FANCY 80 avec spot ON (art. V054) de série;  
> FANCY 40 without spotlight.

**Spessore / Thickness / Épaisseur: 2,2 cm**

**Misure disponibili (LxH) / Dimensions (WxH) / Mesures (LxH)**

- > Art. **S276** 40 x 40
- > Art. **S280** 80 x 80

## SHAPE

**Specchiiera Shape. Luce led perimetrale continua 4000 K di serie (3000 K su richiesta).**  
**Senza interruttore. Orizzontale o verticale**

SHAPE mirror. Continuous perimeter led light 4000K as standard (3000 K on request). Without switch. Horizontal or vertical.

Miroir SHAPE. Éclairage à led périmétral continu 4000K de série (3000 K on request). Sans interrupteur. Horizontal ou vertical

**Spessore / Thickness / Épaisseur: 2,2 cm**

**Misure disponibili (LxH) / Dimensions (WxH) / Mesures (LxH)**

- > Art. **S398** 85 x 73,4
- > Art. **S399** 120 x 73,4

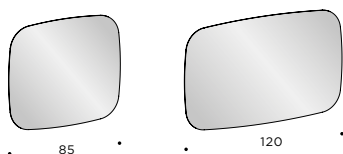

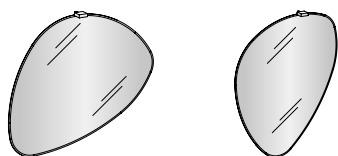

## STONE

Specchiera Stone con bisello 2 cm.  
Faretto Thunder led (art. V832) di serie. Senza interruttore.  
Luce Led perimetrale 4000 K disponibile con maggiorazione (3000 K su richiesta).

Stone mirror with 2 cm bevelled edge.  
THUNDER led spotlight (art. V832) as standard. Without switch.  
4000 K perimeter LED lighting available with surcharge (3000 K on request).

Miroir Stone avec biseau de 2 cm.  
Spot THUNDER led (art. V832) de série. Sans interrupteur.  
Éclairage LED 4000 K périphérique disponible avec supplément (3000 K sur demande).

**Spessore / Thickness / Épaisseur: 2,2 cm**

**Misure disponibili (LxH) / Dimensions (WxH) / Mesures (LxH)**

HORIZONTAL > Art. **S301** 105 x 88

VERTICAL > Art. **S302** 81 x 111,5

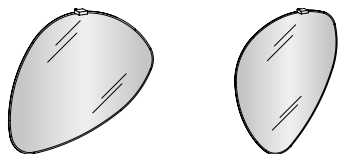

## STONE PICCOLA

Specchiera Stone con bisello 2 cm.  
Faretto Thunder led (art. V832) di serie. Senza interruttore.  
Luce Led perimetrale 4000 K disponibile con maggiorazione (3000 K su richiesta).

Stone mirror with 2 cm bevelled edge.  
THUNDER led spotlight (art. V832) as standard. Without switch.  
4000 K perimeter LED lighting available with surcharge (3000 K on request).

Miroir Stone avec biseau de 2 cm.  
Spot THUNDER led (art. V832) de série. Sans interrupteur.  
Éclairage LED 4000 K périphérique disponible avec supplément (3000 K sur demande).

**Spessore / Thickness / Épaisseur: 2,2 cm**

**Misure disponibili (LxH) / Dimensions (WxH) / Mesures (LxH)**

HORIZONTAL > Art. **S103** 79 x 66

VERTICAL > Art. **S104** 60,5 x 83,5



## SASSO BIG / SMALL

Specchiere SASSO BIG e SASSO SMALL con profilo nero e luce led 4000 K perimetrale. Senza interruttore.

SASSO BIG e SASSO SMALL mirrors. Continuous perimeter led light 4000K as standard. Without switch.

Miroir SASSO BIG et SASSO SMALL. Éclairage à led périmétral continu 4000K de série. Sans interrupteur.

**Spessore / Thickness / Épaisseur: 4 cm**

**Misure disponibili (LxH) / Dimensions (WxH) / Mesures (LxH)**

- > SASSO BIG Art. **X03Z** 94 x 100
- > SASSO SMALL Art. **X040** 40 x 46

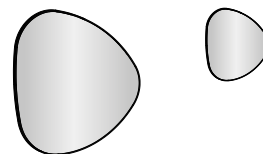



## DAFNE

Specchiera Dafne con cornice in metallo.  
Luce led 4000 K lato superiore. Senza interruttore.

Dafne mirror with metal frame.  
4000 K LED light on the top. No switch.

Miroir Dafne avec cadre en métal.  
Eclairage LED 4000 K sur le dessus. Sans interrupteur.

Spessore / Thickness / Épaisseur: **6,5 cm**

Misure disponibili (LxH) / Dimensions (WxH) / Mesures (LxH)

> Art. **S518** 50 x 100



FINITURE / FINISHES / FINITIONS

Bianco

Nero

Oro



## SOUL

Specchiera Soul con cornice in metallo.  
Luce led 4000 K lato superiore. Senza interruttore.

Soul mirror with metal frame.  
4000 K LED light on the top. No switch.

Miroir Soul avec cadre en métal.  
Eclairage LED 4000 K sur le dessus. Sans interrupteur.

Spessore / Thickness / Épaisseur: **6,5 cm**

Misure disponibili / Dimensions / Mesures

> Art. **S528** Ø 80

> Art. **S828** Ø 100

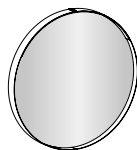

FINITURE / FINISHES / FINITIONS

Bianco

Nero



## TEN

Specchiera TEN decagonale in alluminio nero o oro spazzolato. Luce led 4000 K perimetrale posteriore e interna due lati superiori. Accensione/spengimento touch. Dimmerabile.

TEN decagonal mirror in brushed Nero or Oro aluminium. Rear and two top internal 4000K perimeter led light. Touch on/off.

Miroir TEN décagonal en aluminium nero ou oro brossé. éclairage à led 4000K périmétral arrière et interne deux côtés supérieurs.

Spessore / Thickness / Épaisseur: **5,5 cm**

Misure disponibili (LxH) / Dimensions (WxH) / Mesures (LxH)

> Art. **S430** Ø 80

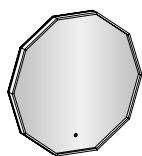

FINITURE / FINISHES / FINITIONS

Oro  
spazzolato

Nero  
spazzolato



## TWELVE

Specchiera TWELVE dodecagonale in alluminio nero o oro spazzolato. Luce led 4000 K perimetrale posteriore e interna due lati superiori. Accensione/spengimento touch. Dimmerabile.

TWELVE dodecagonal mirror in brushed Nero or Oro aluminium. Rear and two top internal 4000K perimeter led light. Touch on/off.

Miroir TWELVE dodécagonal en aluminium nero ou oro brossé. Éclairage à led 4000K périmétral arrière et interne deux côtés supérieurs.

Spessore / Thickness / Épaisseur: **5,5 cm**

Misure disponibili / Dimensions / Mesures

> Art. **S440** Ø 100

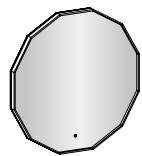

FINITURE / FINISHES / FINITIONS

Oro  
spazzolato

Nero  
spazzolato



## ALMOND

**Specchiera Almond con vetro sp. 1,2 cm smussato. Luce Led perimetrale 3000 K disponibile con maggiorazione (4000 K su richiesta). Senza interruttore.**

Almond mirror with 1.2 cm thick bevelled glass. 3000 K perimeter LED lighting available with surcharge (4000 K on request). Without switch.

Miroir Almond avec verre biseauté de 1,2 cm d'épaisseur. Éclairage LED 3000 K périphérique disponible avec supplément (4000 K sur demande). Sans interrupteur.

**Spessore / Thickness / Épaisseur: 3 cm**

**Misure disponibili (LxH) / Dimensions (WxH) / Mesures (LxH)**

- > Art. **X046** 85 x 85
- > Art. **X045** 100 x 85

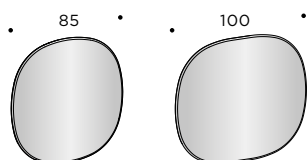

## ROCK

**Specchiera Rock con struttura in alluminio microforato nero opaco e luce led integrata 3000 K. Specchio sp. 5 mm bisellato. Interruttore touch dimmer incluso nel lato inferiore (con luce di cortesia).**

Rock mirror with matt black micro-perforated aluminium frame and integrated 3000 K LED light. 5 mm thick bevelled mirror. Touch dimmer switch included on the underside (with courtesy light).

Miroir Rock avec structure en aluminium microperforé noir mat et éclairage LED intégré 3000 K. Miroir de 5 mm d'épaisseur avec bord biseauté. Interrupteur tactile avec variateur intégré dans la partie inférieure (avec éclairage d'appoint).

**Spessore / Thickness / Épaisseur: 2,3 cm**

**Misure disponibili (LxH) / Dimensions (WxH) / Mesures (LxH)**

- > Art. **X04B** 70 x 74,5
- > Art. **X04A** 94 x 100

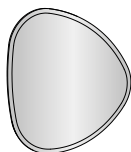

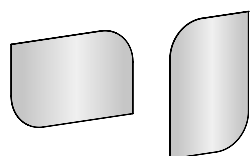

## LEAF

Specchiera Leaf con luce led 3000 K perimetrale (4000 K su richiesta). Senza interruttore. Orizzontale o verticale.

Leaf mirror with 3000 K LED perimeter lighting (4000 K on request). No switch. Horizontal or vertical.

Miroir Leaf avec éclairage LED 3000 K sur le pourtour (4000 K sur demande). Sans interrupteur. Horizontal ou vertical.

Spessore / Thickness / Épaisseur: **2,2 cm**

Misure disponibili (LxH) / Dimensions (WxH) / Mesures (LxH)

- > Art. **X04C** 70 x 61,2
- > Art. **X04D** 85 x 61,2
- > Art. **X04E** 95 x 61,2
- > Art. **X04F** 105 x 61,2
- > Art. **X04G** 120 x 61,2

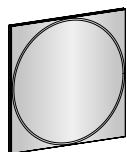

## EUCLIDE

Specchiera Euclide con telaio in alluminio Brill. Luce led integrata 3000 K. Senza interruttore

Euclide mirror with Brill aluminium frame. Integrated 3000 K LED light. Without switch.

Miroir Euclide avec cadre en aluminium Brill. Éclairage LED intégré 3000 K. Sans interrupteur.

Spessore / Thickness / Épaisseur: **2,5 cm**

Misure disponibili (LxH) / Dimensions (WxH) / Mesures (LxH)

- > Art. **X04H** 70 x 70
- > Art. **X04I** 85 x 85
- > Art. **X04J** 95 x 95

EUCLIDE





## APP

Specchiere App con telaio in alluminio nero. Spicchio superiore retroilluminato con luce led 3000 K (4000 K su richiesta). Senza interruttore.

Mirror App with black aluminium frame. Upper segment backlit with 3000 K LED light (4000 K on request). No switch.

Miroirs App avec cadre en aluminium noir. Segment supérieur rétroéclairé avec lumière LED 3000 K (4000 K sur demande). Sans interrupteur.

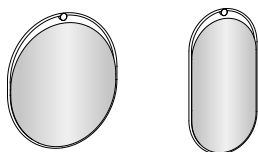

Spessore / Thickness / Épaisseur: **3 cm**

Misure disponibili (LxH) / Dimensions (WxH) / Mesures (LxH)

- > Art. **X048** 83 x 92
- > Art. **X047** 55 x 106

APP





## ALMOND CONTENITORE

**Specchiera Almond contenitore - 1 anta dx.**  
 1 anta fissa L 28,5 + anta dx L 56,5 cm.  
 Struttura in metallo nero L 71 x H 46 x P 13 cm.  
 Compresa di ripiano interno in vetro, luce 3000 K, presa shuko.  
 Compatibile con faretto Ellipse maxi

Almond mirror cabinet - 1 right-hand door.  
 1 fixed door L 28.5 + right-hand door L 56.5 cm.  
 Black metal frame L 71 x H 46 x D 13 cm.  
 Includes internal glass shelf, 3000 K light, Schuko socket.  
 Compatible with Ellipse maxi spotlight.

Miroir Almond avec rangement - 1 porte à droite.  
 1 porte fixe L 28,5 + porte à droite L 56,5 cm.  
 Structure en métal noir L 71 x H 46 x P 13 cm.  
 Comprend une étagère intérieure en verre, éclairage 3000 K,  
 prise shuko. Compatible avec le spot Ellipse maxi.

**Spessore / Thickness / Épaisseur: 13,6 cm**

**Misure disponibili (LxH) / Dimensions (WxH) / Mesures (LxH)**

> Art. **XO49** 85 x 85

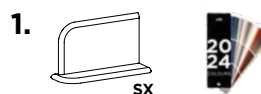
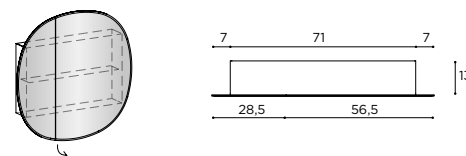

**1.** SX

**Mensola dx-sx sp. 2,2 cm e P 12,6 cm con bordo Almond.**  
 Disponibile in finitura laccato colore opaco e metal.

Right-left shelf, thickness 2.2 cm and depth 12.6 cm with Almond edge. Available in matt lacquered and metallic finishes.

Étagère droite-gauche ép. 2,2 cm et P 12,6 cm avec bord Almond. Disponible en finition laquée couleur mate et métal.

> Art. **ACOA** 32 x 24,2

> Art. **AC09** 42 x 24,2



**2.**  
**Faretto Ellipse maxi a luce led (completo di alimentatore separato). Finitura nero.**

24 V - 2 W - 170/180 lumen - 3000 K (luce naturale) - IP20

Spot Ellipse maxi à LED (avec alimentation séparée).  
 Finition noire. 24 V - 2 W - 170/180 lumens -  
 3000 K (lumière naturelle) - IP20

Spot Ellipse maxi à LED (avec alimentation séparée).  
 Finition noire. 24 V - 2 W - 170/180 lumens -  
 3000 K (lumière naturelle) - IP20

> Art. **ACOG** 8,5 x 19

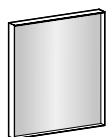

## OVER

**Specchiera Over in metallo nero. Led 3000 K superiore, 690 lumen (compreso di alimentatore 230 V). Senza interruttore.**

Over mirror in black metal. Upper 3000 K LED, 690 lumens (including 230 V power supply). Without switch.

Miroir Over en métal noir. LED 3000 K supérieure, 690 lumens (alimentation 230 V incluse). Sans interrupteur.

**Spessore / Thickness / Épaisseur: 6,5 cm**

**Misure disponibili (LxH) / Dimensions (WxH) / Mesures (LxH)**

> Art. **X043** 60 x 71

## OVER CONTENITORE

**Specchiera contenitore Over in metallo nero, con ripiani in vetro. Led 3000 K superiore, 690 lumen (alimentatore 230V incluso). Accensione touchless sul lato inferiore e presa interna schuko. La specchiera non è reversibile.**

Over mirror cabinet in black metal, with glass shelves. 3000 K LED light above, 690 lumens (230V power supply included). Touchless switch on the bottom and internal Schuko socket. The mirror is not reversible.

Miroir conteneur Over en métal noir, avec étagères en verre. LED 3000 K supérieure, 690 lumens (alimentation 230 V incluse). Allumage sans contact sur la partie inférieure et prise interne Schuko. Le miroir n'est pas réversible.

**Spessore / Thickness / Épaisseur: 18 cm**

**Misure disponibili (LxH) / Dimensions (WxH) / Mesures (LxH)**

> Art. **X044** 60 x 71

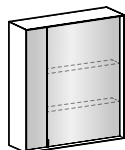



**Scatola a scomparsa con interruttore faretto e presa Schuko (230V - max 1500W)**

Recessed box with spotlight switch and Schuko socket (230V - max 1500W)

Boîte encastrée avec interrupteur spots et prise Schuko (230V - max 1500W)

## SINTESI

**Specchiera Sintesi con 1, 2 o 3 ante specchio dx-sx con specchio interno. Faretto Flash led (art. V818)**

Sintesi mirror with 1, 2 or 3 right-left mirror doors with internal mirror. Flash LED spotlight (item V818)

Miroir Sintesi avec 1, 2 ou 3 portes miroir droite-gauche avec miroir intérieur. Spot Flash LED (art. V818)

**Spessore / Thickness / Épaisseur: 18 cm**

**Misure disponibili (LxH) / Dimensions (WxH) / Mesures (LxH)**

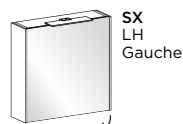

> Art. **S552** 62,4 x 61,2

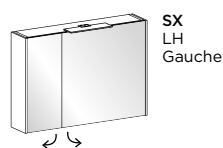

> Art. **S553** 72,4 x 61,2  
> Art. **S554** 87,4 x 61,2

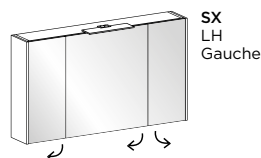

> Art. **S555** 97,4 x 61,2  
> Art. **S556** 107,4 x 61,2  
> Art. **S557** 122,4 x 61,2

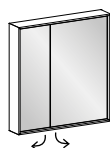
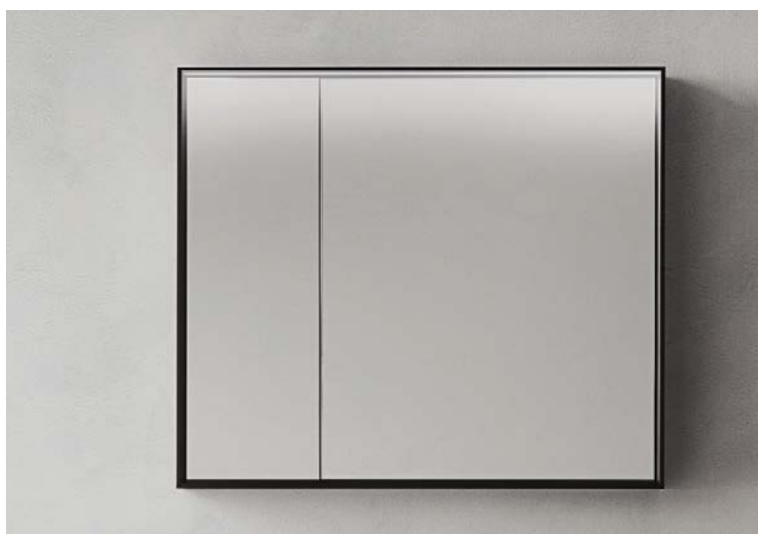

**FINITURE / FINISHES / FINITIONS**

**Nero**  
spazzolato

**Inox**  
spazzolato

## NEBULA

**Specchiera Nebula. 2 ante specchio con specchi interni (doppio specchio accoppiato sp. 6 mm).**

**Senza presa/interruttore. Struttura in alluminio ossidato.**

**Led anteriore integrato a tutta lunghezza 4000 K.**

**N.B. Le ante non sono reversibili**

Nebula mirror. 2 mirror doors with internal mirrors (double mirror, thickness 6 mm). Without socket/switch. Oxidised aluminium frame. Integrated full-length front LED lighting, 4000 K.

N.B. The doors are not reversible.

Miroir Nebula. 2 portes miroir avec miroirs internes (double miroir couplé épaisseur 6 mm).

Sans prise/interrupteur. Structure en aluminium oxydé.

LED avant intégrée sur toute la longueur 4000 k.

N.B. Les portes ne sont pas réversibles.

**Spessore / Thickness / Épaisseur: 13 cm**

**Misure disponibili (LxH) / Dimensions (WxH) / Mesures (LxH)**

> Art. **S686** 70 x 73,4  
> Art. **S687** 85 x 73,4  
> Art. **S688** 95 x 73,4  
> Art. **S689** 105 x 73,4  
> Art. **S690** 120 x 73,4



## DIVA

**Specchiera contenitore DIVA con 1, 2 o 3 ante specchio. Faretto led FLASH (art. V818) di serie, specchi interni e vano a giorno con spot led (1 W).**

DIVA mirror with 1, 2 or 3 mirror doors. FLASH led spotlight (item V818), internal mirrors and open unit with spot leds (1 W).

Miroir de rangement DIVA avec avec avec 1, 2 ou 3 portes miroir. Spot FLASH à led (art. V818) de série, miroirs internes et élément ouvert avec spot leds (1 W).

**Spessore / Thickness / Épaisseur: 18 cm**

**Misure disponibili (LxH) / Dimensions (WxH) / Mesures (LxH)**

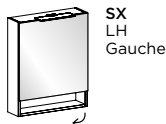

> Art. **S546** 60 x 73,4

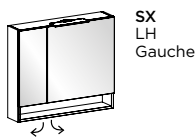

> Art. **S547** 70 x 73,4  
> Art. **S548** 85 x 73,4

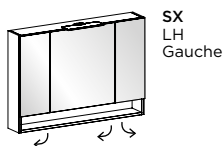

> Art. **S549** 95 x 73,4  
> Art. **S550** 105 x 73,4  
> Art. **S551** 120 x 73,4



**Scatola a scomparsa con interruttore faretto e presa Schuko (230V - max 1500W)**

Recessed box with spotlight switch and Schuko socket (230V - max 1500W)

Boîte encastrée avec interrupteur spots et prise Schuko (230V - max 1500W)



## CHIC

**Specchiera contenitore CHIC con 1, 2 o 3 ante specchio. Faretto led WIN (art. V119)**

CHIC mirror with 1, 2 or 3 right-left mirror doors. WIN led spotlight (item V119).

Miroir de rangement CHIC avec avec avec 1, 2 ou 3 portes miroir. Spot WIN à led (art. V119).

**Spessore / Thickness / Épaisseur: 18 cm**

**Misure disponibili (LxH) / Dimensions (WxH) / Mesures (LxH)**

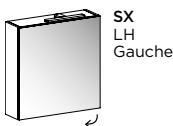

> Art. **S989** 60 x 73,4

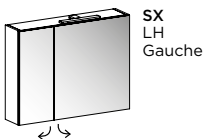

> Art. **S990** 70 x 73,4  
> Art. **S654** 85 x 73,4

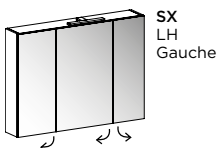

> Art. **S655** 95 x 73,4  
> Art. **S656** 105 x 73,4  
> Art. **S991** 120 x 73,4



**Scatola interna con interruttore faretto e presa Schuko (230V - max 1500W)**

Inner box with spotlight switch and Schuko socket (230V - max 1500W)

Boîte intérieure avec interrupteur spots et prise Schuko (230V - max 1500W)



**Scatola interna con interruttore faretto e presa Schuko (230V - max 1500W)**

Inner box with spotlight switch and Schuko socket (230V - max 1500W)

Boîte intérieure avec interrupteur spots et prise Schuko (230V - max 1500W)

## OSLO

**Specchiera contenitore oslo con faretto led WIN (art. V119).**

OSLO mirror-fronted cabinet with WIN led spotlight (item V119).

Miroir de rangement OSLO avec spot WIN à led (art. V119).

**Spessore / Thickness / Épaisseur: 18 cm**

**Misure disponibili (LxH) / Dimensions (WxH) / Mesures (LxH)**

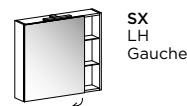

> Art. **S637** 70 x 73,4  
> Art. **S467** 85 x 73,4

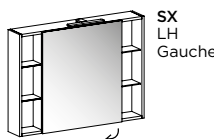

> Art. **S468** 95 x 73,4  
> Art. **S469** 105 x 73,4  
> Art. **S638** 120 x 73,4

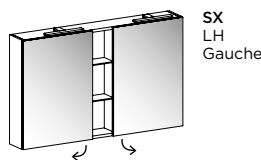

> Art. **S639** 120 x 73,4



**Scatola a scomparsa con interruttore faretto e presa Schuko (230V - max 1500W)**

Recessed box with spotlight switch and Schuko socket (230V - max 1500W)

Boîte encastrée avec interrupteur spots et prise Schuko (230V - max 1500W)

## SIDE

**Specchiera contenitore SIDE con faretto led FLASH (art. V818) di serie, specchi interni e spot led.**

SIDE mirror-fronted cabinet standard with FLASH led spotlight (item V818), internal mirrors and spot leds.

Miroir de rangement SIDE avec spot FLASH à led (art. V818) de série, miroirs internes et spot leds.

**Spessore / Thickness / Épaisseur: 18 cm**

**Misure disponibili (LxH) / Dimensions (WxH) / Mesures (LxH)**

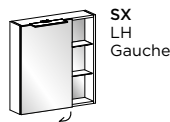

> Art. **S540** 70 x 73,4  
> Art. **S541** 85 x 73,4

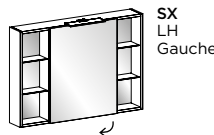

> Art. **S542** 95 x 73,4  
> Art. **S544** 105 x 73,4  
> Art. **S543** 120 x 73,4

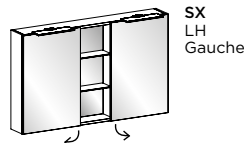

> Art. **S566** 120 x 73,4  
> Art. **S545** 140 x 73,4

SIDE



# FARETTI

---

SPOTLIGHTS  
SPOTS



## LASER

Barra a luce led LASER (completo di alimentatore separato).

LASER strip light (complete with separate power supply).

Barre d'éclairage à led LASER (avec alimentateur séparé incluse).

IP44 - 4000 K **luce naturale** / natural light / lumière naturelle

**Misure disponibili (L) /**

Dimensions (W) / Mesures (L)

	Brill	Nero
> <b>70</b> (5,4 W - 24 V - 980 lumen)	<b>V283 - V339</b>	
> <b>85</b> (6,5 W - 24 V - 1190 lumen)	<b>V284 - V340</b>	
> <b>95</b> (7,3 W - 24 V - 1330 lumen)	<b>V285 - V341</b>	
> <b>105</b> (8 W - 24 V - 1470 lumen)	<b>V286 - V342</b>	
> <b>120</b> (9,4 W - 24 V - 1680 lumen)	<b>V287 - V343</b>	
> <b>140</b> (11 W - 24 V - 1960 lumen)	<b>V288 - V344</b>	

**Fuori misura / Out of standard / Sur mesure**

> **V289** (Brill)

> **V290** (Nero)



Brill

Nero



## TRAIL

Barra a luce led TRAIL (alimentatore integrato).

TRAIL strip light (built-in power supply).

Barre d'éclairage à led TRAIL (alimentateur intégré).

IP44 - 4000 K **luce naturale** / natural light / lumière naturelle

**Misure disponibili (L) / Dimensions (W) / Mesures (L)**

> <b>40</b> (10 W - 230 V - 1175 lumen)	<b>V167</b>
> <b>60</b> (15 W - 230 V - 1531 lumen)	<b>V168</b>
> <b>80</b> (20 W - 230 V - 2200 lumen)	<b>V169</b>
> <b>100</b> (25 W - 230 V - 2852 lumen)	<b>V170</b>

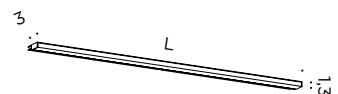

Cromo



## MIKY NEW

Faretto a luce led MIKY NEW (alimentatore integrato).

MIKY NEW spotlight (built-in power supply).

Spot MIKY NEW avec éclairage à led (alimentateur intégré).

IP23 - 4000/3000 K  
230 V - 10 W - 583 lumen

- > L 53 - 4000 K Art. **V631** (brill) - **V633** (nero)
- > L 53 - 3000 K Art. **V635** (brill)

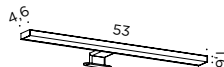

Brill

Nero



## PLEXI 30-45

Faretto a luce led PLEXI 30-45 in metacrilato (alimentatore integrato).

PLEXI 30-45 methacrylate led-spotlight (built-in power supply).

Spot PLEXI 30-45 à led en méthacrylate (alimentateur intégré).

IP44 - 4000 K luce naturale / natural light / lumière naturelle  
230 V - 8W

- > L 30 810 lm Art. **V034**
- > L 45 1.188 lm Art. **V124**

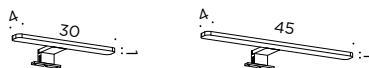

## THUNDER

Faretto orientabile luce led THUNDER (alimentatore separato incluso).

THUNDER adjustable led-spotlight (separate power supply included).

Spot THUNDER avec éclairage à led (avec alimentateur séparé incluse).

IP44 - 4000 K luce naturale / natural light / lumière naturelle  
12 V - 2,4 W - 217 lumen

- > Art. **V832**

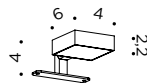



## ISLAND

Faretto a luce led ISLAND (alimentatore integrato).

ISLAND spotlight (built-in power supply).

Spot ISLAND avec éclairage à led (alimentateur intégré).

IP44 - 4000 K **luce naturale** / natural light / lumière naturelle  
230 V - 6 W - 554 lumen

> Art. **V830**

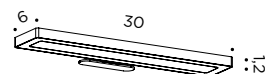

Cromo  
lucido

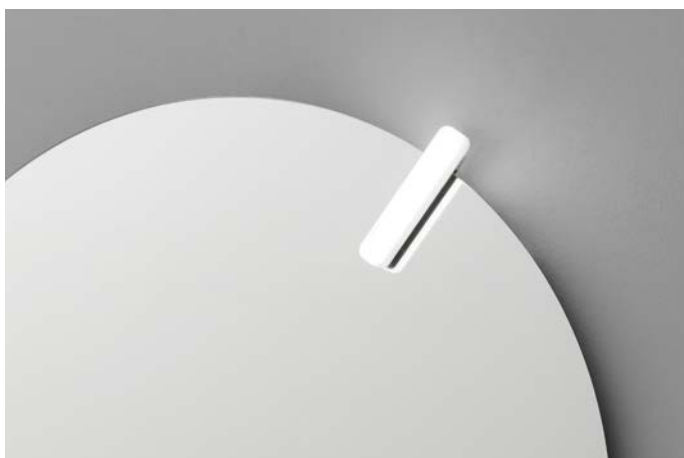

## ON

Faretto ON a luce led in metacrilato (alimentatore separato incluso).

Methacrylate led-spotlight ON (separate power supply included).

Spot ON à led en méthacrylate (avec alimentateur séparé incluse).

IP44 - 4000 K **luce naturale** / natural light / lumière naturelle  
12 V - 3,3 W - 360 lumen

> Art. **V054**

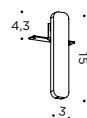

Brill

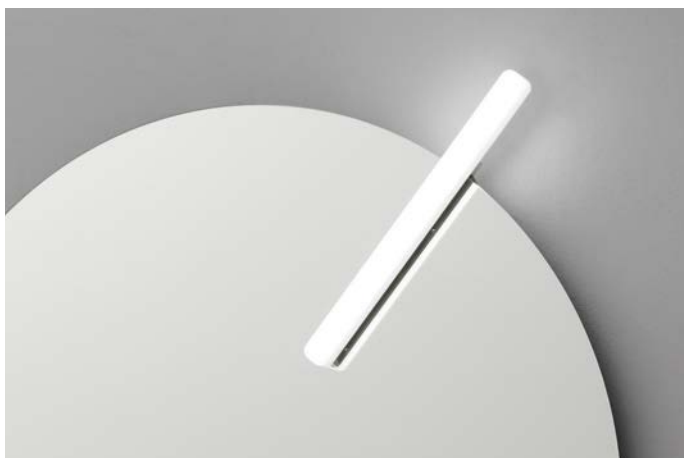

## OFF

Faretto OFF a luce led in metacrilato (alimentatore separato incluso).

Methacrylate led-spotlight OFF (separate power supply included).

Spot OFF à led en méthacrylate (avec alimentateur séparé incluse).

IP44  
4000 K **luce naturale** / natural light / lumière naturelle  
12 V - 8,2 W - 880 lumen

> Art. **V055**

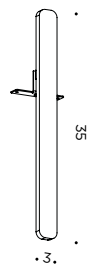

Brill



## TIARA

Faretto a luce led in metacrilato (alimentatore separato incluso).  
Solo per specchiere LIGHT TONDA Ø 85 - 100 - 120.

Methacrylate led-spotlight (separate power supply included).  
Only for LIGHT TONDA mirrors Ø 85 - 100 - 120

Spot à led en méthacrylate (avec alimentateur séparé incluse).  
Uniquement pour miroirs LIGHT TONDA Ø 85 - 100 - 120.

IP44 - 4000 K **luce naturale** / natural light / lumière naturelle  
12 V - 8,2 W - 900 lumen

> Art. **V057**

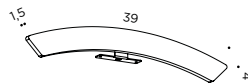

Brill



## FLASH

Faretto a luce led FLASH (alimentatore separato incluso).

LED-spotlight FLASH (separate power supply included).

Spot FLASH avec éclairage à led (avec alimentateur séparé incluse).

IP44 - 4000 K **luce naturale** / natural light / lumière naturelle  
12 V - 7,9 W - 752 lumen

> Art. **V818**

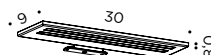

Acciaio  
mirror



## WIN

Faretto a luce led WIN (alimentatore integrato).

WIN spotlight (built-in power supply).

Spot WIN avec éclairage à led (alimentateur intégré).

IP44 - 4000 K **luce naturale** / natural light / lumière naturelle  
24 V - 4,4 W - 550 lumen

> Art. **V119**

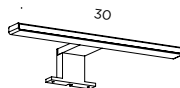

Acciaio  
mirror

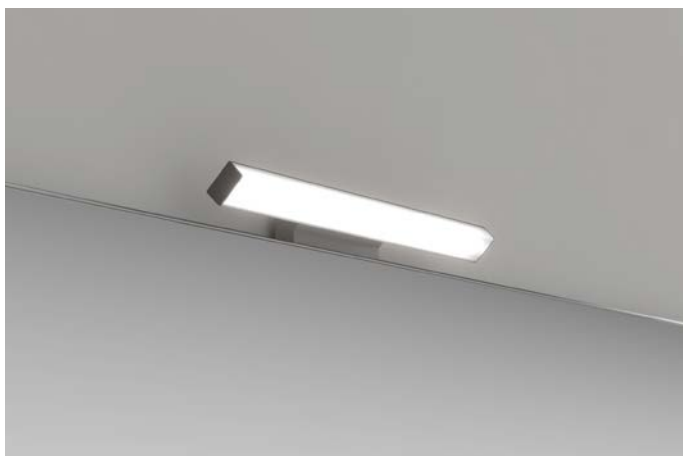

## LUX e LUX XL

Faretto a luce led (alimentatore integrato).

LED-spotlight (built-in power supply).

Spot avec éclairage à led (alimentateur intégré).

IP44 - 4000 K **luce naturale** / natural light / lumière naturelle

> **LUX** Art. **V249** - 230 V - 3,4 W - 604 lumen

> **LUX XL** Art. **V250** - 230 V - 4,4 W - 1006 lumen

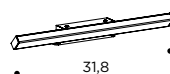

31,8



51,8

Alluminio



## BLISTER

Faretto a luce led (alimentatore integrato).

LED-spotlight (built-in power supply).

Spot avec éclairage à led (alimentateur intégré).

IP44 - LAMPADINA G9  
4000 K **luce naturale** / natural light / lumière naturelle  
230 V - 3 W - 260 lumen

> Art. **V246**



Cromo

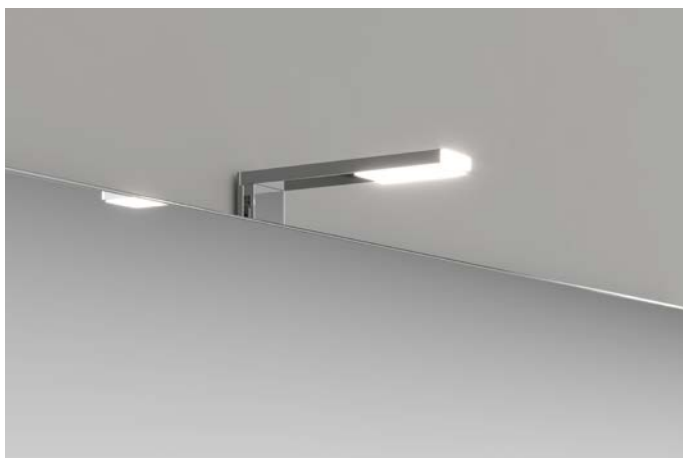

## BRIO

Faretto a luce led (alimentatore integrato).

LED-spotlight (built-in power supply).

Spot avec éclairage à led (alimentateur intégré).

IP44 - 4000 K **luce naturale** / natural light / lumière naturelle  
230 V - 3,5 W - 365 lumen

> Art. **V248**

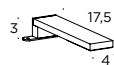

Cromo



## KEVIN

**Faretto a luce led Ø 10 x Sp. 2 cm (alimentatore integrato).**  
LED-spotlight Ø 10 x th. 2 cm (built-in power supply).  
Spot avec éclairage à led Ø 10 x ép. 2 cm (alimentateur intégré).

IP44 - 4000 K **luce naturale** / natural light / lumière naturelle  
230 V - 4 W - 445 lumen

Art. **V291**

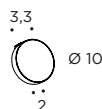

Cromo



## YO-YO

**Faretto a luce led Ø 8 cm (alimentatore integrato).**  
LED-spotlight Ø 8 cm (built-in power supply).  
Spot avec éclairage à led Ø 8 cm (alimentateur intégré).

IP44 - LAMPADINA G9  
4000 K **luce naturale** / natural light / lumière naturelle  
230 V - 5 W - 603 lumen

Art. **V247**

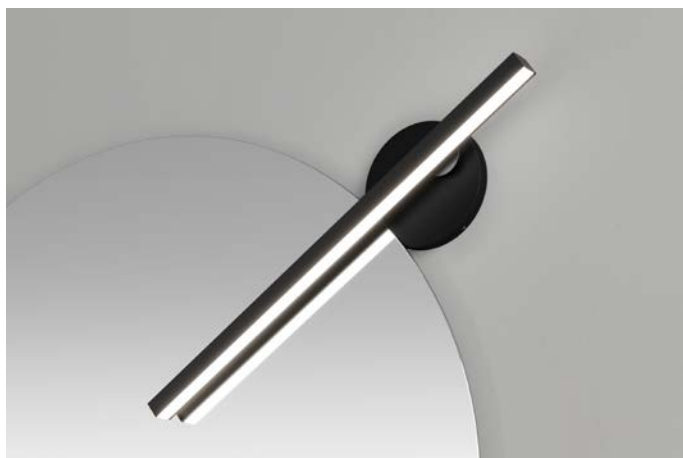

## MERIDIANA

**Faretto a luce led L 52 cm (alimentatore integrato).**  
**Struttura Bianca o Nera e metacrilato satinato.**

LED-spotlight W 52 cm (built-in power supply).  
Bianco or Nero structure and satin-finish methacrylate.

Spot avec éclairage à led L 52 cm (alimentateur intégré).  
Structure Bianca ou Nero et méthacrylate satiné.

4000 K **luce naturale** / natural light / lumière naturelle  
230 V - 12 W - 1100 lumen

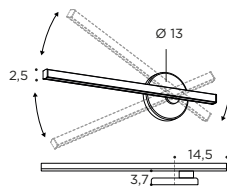

> Art. **V834** Bianco  
> Art. **V281** Nero

Bianco

Nero



## DROP

Faretto luce led a parete (alimentatore integrato).

Wall LED-spotlight (built-in power supply).

Spot à mur avec éclairage à led (alimentateur intégré).

IP44 - 4000 K **luce naturale** / natural light / lumière naturelle  
230 V - 5 W - 350 lumen

Art. **V835**

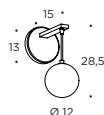

Nero



## SOLEIL

Faretto a luce led L 36,5 x sp. 2,7 cm (alimentatore separato incluso).

LED-spotlight W. 36.5 x th. 2.7 cm (separate power supply included).

Spot avec éclairage à led L 36,5 x ép. 2,7 cm (avec alimentateur séparé).

IP44 - 4000 K **luce naturale** / natural light / lumière naturelle  
24 V - 7,5 W - 750 lumen

> Art. **AB18** Brill

> Art. **AB19** Nero

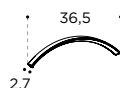

Brill

Nero



## COTÈ

Faretto a luce led sp. 2,7 cm (alimentatore separato incluso).

LED-spotlight th. 2.7 cm (separate power supply included).

Spot avec éclairage à led ép. 2,7 cm (avec alimentateur séparé incluse).

24 V - 4000 K **luce naturale** / natural light / lumière naturelle  
IP44

> Art. **AB15** Ø 70 - 11 W - 1100 lumen

> Art. **AB16** Ø 85 - 13 W - 1300 lumen

> Art. **AB17** Ø 100 - 15,5 W - 1500 lumen

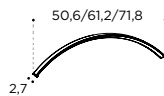

Brill



## ELLIPSE MINI

Faretto a luce led L 3 x H 10 x P 8,5 cm (alimentatore separato incluso).

LED-spotlight W 3 x H 10 x D 8.5 cm (separate power supply included).

Spot avec éclairage à led L 3 x H 10 x P 8,5 cm (avec alimentateur séparé).

IP20 - 3000 K **luce calda** / warm light / lumière chaude  
24 V - 2 W - 170/180 lumen

Art. **ACOH**



Nero



## BOLLA

Faretto a luce led L 9 x H 22 x P 19 cm (alimentatore separato incluso).

LED-spotlight W 9 x H 22 x D 19 cm (separate power supply included).

Spot avec éclairage à led L 9 x H 22 x P 19 cm (avec alimentateur séparé).

IP20 - 3000 K **luce calda** / warm light / lumière chaude  
230 V - 5 W - 400/450 lumen

Art. **ACOF**

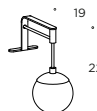

Nero

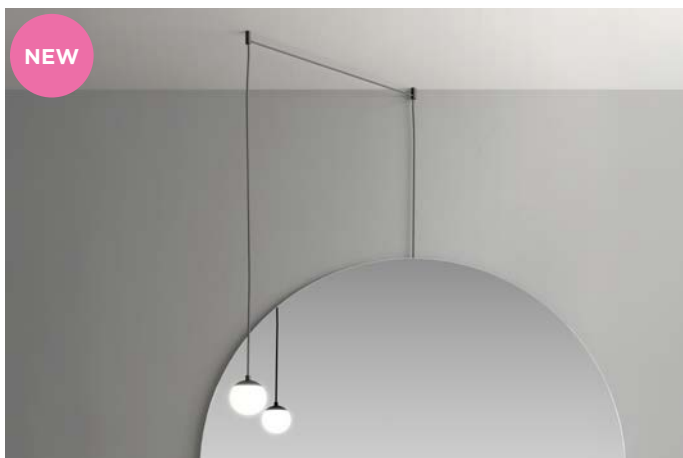

## BOLLA PENDANT

Faretto pendente a luce led Ø 10 cm (alimentatore separato incluso).  
Inclusi due supporti per soffitto e cavo L 3 m.

Pendant LED-spotlight Ø 10 cm (separate power supply included).  
Includes two ceiling mounts and a 3 m cable.

Spot à suspension avec éclairage à led Ø 10 cm (avec alimentateur  
séparé incluse). Deux supports pour plafond et câble de 3 m inclus.

IP20 - 3000 K **luce calda** / warm light / lumière chaude  
230 V - 5 W - 400/450 lumen



Art. **AB23**

Nero



## LABEL

Faretto a luce led L 2,5 x H 31,5 x P 15 cm (alimentatore separato incluso).

LED-spotlight W 2,5 x H 31,5 x D 15 cm (separate power supply included).

Spot avec éclairage à led L 2,5 x H 31,5 x P 15 cm (avec alimentateur séparé).

IP20 - 3000 K **luce calda** / warm light / lumière chaude  
230 V - 5 W - 400/450 lumen

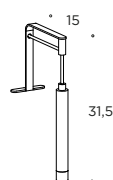

Art. **ACOE**

Nero



## LABEL PENDANT

Faretto pendente a luce led L 2,5 x H 20 cm (alimentatore separato incluso). Inclusi due supporti per soffitto e cavo L 3 m.

Pendant LED-spotlight W 2.5 x H 20 cm (separate power supply included). Includes two ceiling mounts and a 3 m cable.

Spot à suspension avec éclairage à led L 2,5 x H 20 cm (avec alimentateur séparé incluse). Deux supports pour plafond et câble de 3 m inclus.

IP20 - 3000 K **luce calda** / warm light / lumière chaude  
230 V - 5 W - 400/450 lumen

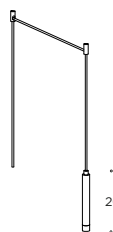

Art. **AB22**

Nero



WHISKY 53  
bianco lucido

02.

---

# RUBINETTI E LAVABI

---

WASHBASIN MIXERS  
AND WASHBASINS

MITIGEURS LAVABO  
ET LAVABOS



## GEKO

RUBINETTI COLORATI  
COLORED WASHBASIN MIXERS  
MITIGEUR LAVABO COLORÉS

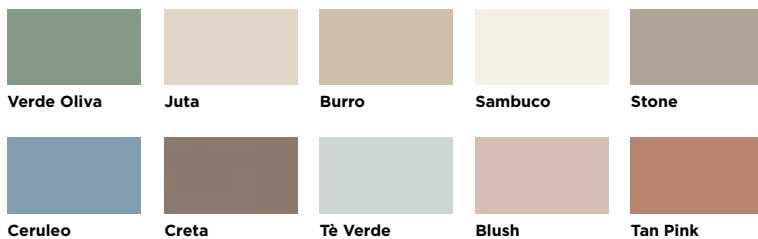

Tutti i colori della mazzetta Arbi sono disponibili con un sovrapprezzo del 20%  
All colours in the Arbi colour chart are available at a 20% surcharge.  
Toutes les couleurs du nuancier Arbi sont disponibles moyennant un supplément de 20%.

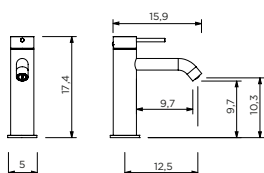

Miscelatore a leva singola  
Single lever mixer  
Mitigeur à levier unique

> Art. **G001**

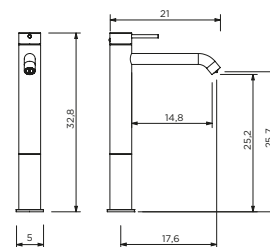

Miscelatore alto a leva singola  
Single lever high mixer  
Mitigeur haut à levier unique

> Art. **G002**

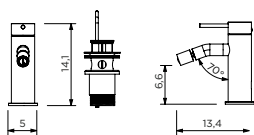

Miscelatore a leva singola per bidet con salterello e scarico  
Single lever mixer for bidet with pop-up waste and drain  
Mitigeur à levier unique pour bidet avec clapet et vidage

> Art. **G00B**

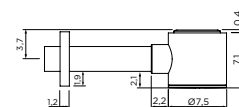

Sifone compatto  
Compact siphon  
Siphon compact

> Art. **AN02**

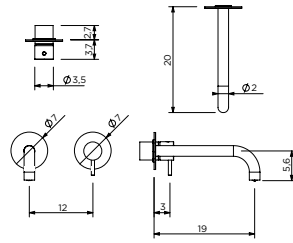

Miscelatore a parete due fori con canna d'erogazione L 19 cm.  
 Uso tassativo con gruppo incasso art. G005

Two-hole wall mixer with 19 cm spout.  
 Must be used with concealed unit art. G005.

Mitigeur mural à deux trous avec bec verseur L 19 cm.  
 Utilisation obligatoire avec le groupe encastré art. G005.

> Art. **G003**

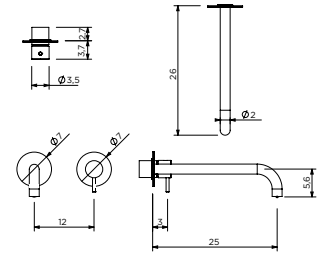

Miscelatore a parete due fori con canna d'erogazione L 25 cm.  
 Uso tassativo con gruppo incasso art. G005

Two-hole wall mixer with 25 cm spout.  
 Must be used with concealed unit art. G005.

Mitigeur mural à deux trous avec bec verseur L 25 cm.  
 Utilisation obligatoire avec le groupe encastré art. G005.

> Art. **G004**

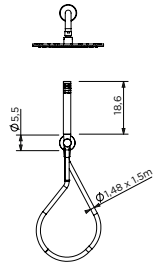
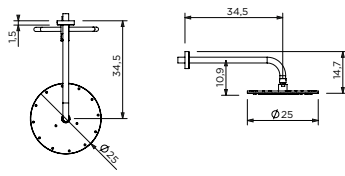

> Art. **G00C** flessibile Nero  
 > Art. **GOOD** flessibile Bianco

Kit doccia con soffione a pioggia  
 Ø 25 cm sp. 0,8 cm, braccio a parete  
 e kit presa acqua. Consigliato con  
 miscelatore doccia G007

Shower kit with rain shower head Ø  
 25 cm, thickness 0.8 cm, wall bracket  
 and water connection kit. Recom-  
 mended with shower mixer G007.

Kit douche avec pomme de douche  
 Ø 25 cm ép. 0,8 cm, bras mural et  
 kit prise d'eau. Recommandé avec le  
 mitigeur de douche G007.

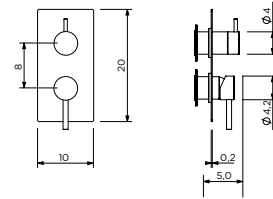

Miscelatore doccia multiplo.  
 Uso tassativo con gruppo incasso art. G006

Multiple shower mixer.  
 Must be used with concealed unit art. G006.

Mitigeur de douche multiple.  
 Utilisation obligatoire avec le groupe encastré art. G006.

> Art. **G007**



BRANDY 42  
acrilico Verde



## EASY 42

Ocritech - Acrilico / Acrylic / Acrylique

Lavabo Tutto Fuori in ocritech o acrilico.  
Per basi portalavabo min. L 50 cm

Tutto Fuori washbasin in ocritech or acrylic.  
Washbasin units min. W 50 cm

Lavabo à poser en ocritech ou acrylique.  
Éléments sous lavabo min. L 50 cm

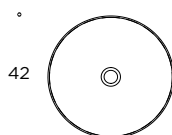

> Art. **ROOX**



## EASY 55

Ocritech - Acrilico / Acrylic / Acrylique

Lavabo Tutto Fuori in ocritech o acrilico.  
Per basi portalavabo min. L 60 cm

Tutto Fuori washbasin in ocritech or acrylic.  
Washbasin units min. W 60 cm

Lavabo à poser en ocritech ou acrylique.  
Éléments sous lavabo min. L 60 cm

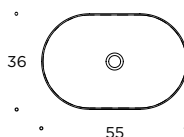

> Art. **ROOY**



## BRANDY 42

Ocritech - Acrilico / Acrylic / Acrylique

Lavabo Tutto Fuori in ocritech o acrilico.  
Per basi portalavabo min. L 50 cm

Tutto Fuori washbasin in ocritech or acrylic.  
Washbasin units min. W 50 cm

Lavabo à poser en ocritech ou acrylique.  
Éléments sous lavabo min. L 50 cm

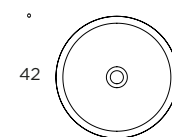

> Art. **ROOW**





## ATHENA 40

Ocritech - Acrilico / Acrylic / Acrylique

Lavabo Tutto Fuori in ocritech o acrilico.  
Per basi portalavabo min. L 50 cm

Tutto Fuori washbasin in ocritech or acrylic.  
Washbasin units min. W 50 cm

Lavabo à poser en ocritech ou acrylique.  
Éléments sous lavabo min. L 50 cm



> Art. **R015**



## ATHENA 60

Ocritech - Acrilico / Acrylic / Acrylique

Lavabo Tutto Fuori in ocritech o acrilico.  
Per basi portalavabo min. L 60 cm

Tutto Fuori washbasin in ocritech or acrylic.  
Washbasin units min. W 60 cm

Lavabo à poser en ocritech ou acrylique.  
Éléments sous lavabo min. L 60 cm

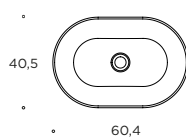

> Art. **R016**



## FLOW

Vetro / Glass / Verre

Lavabo tutto fuori in vetro. Incluso anello distanziatore H 10 mm nero opaco.  
Per basi portalavabo min. L 60 cm

All-glass washbasin. Includes 10 mm matt black spacer ring.  
For washbasin bases min. L 60 cm

Lavabo à poser en verre. Anneau d'écartement H 10 mm noir mat inclus.  
Pour meubles sous lavabo min. L 60 cm

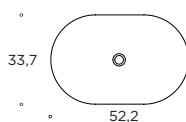

> Art. **R00U**



FLOW  
vetro Blu



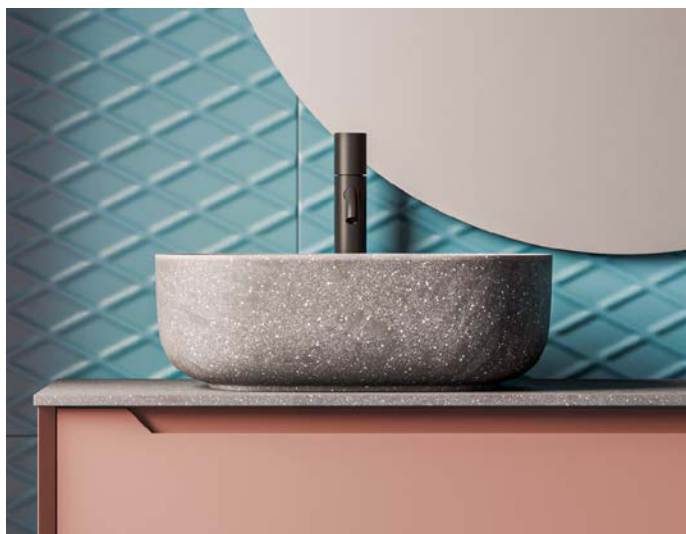

## MILÙ 45

Tekno - Ecopietra

Lavabo tutto fuori in Tekno Deimos Bianco, Tekno Colore e Ecopietra. Compresa piletta S&G in finitura. Per basi portalavabo min. L 50 cm

Countertop washbasin in Tekno Deimos Bianco, Tekno Colore and Ecopietra. Including S&G drain in matching finish. Washbasin units min. W 50 cm

Lavabo à poser en Tekno Deimos Bianco, Tekno Colore et Ecopietra. Y compris bonde S&G dans la finition. Éléments sous lavabo min. L 50 cm

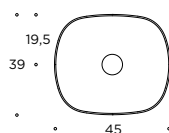

> Art. **A752** Tekno Deimos Bianco / Tekno Colore  
> Art. **A753** ECOPIETRA



## MILÙ 60

Tekno - Ecopietra

Lavabo tutto fuori in Tekno Deimos Bianco, Tekno Colore e Ecopietra. Compresa piletta S&G in finitura. Per basi portalavabo min. L 60 cm

Countertop washbasin in Tekno Deimos Bianco, Tekno Colore and Ecopietra. Including S&G drain in matching finish. Washbasin units min. W 60 cm

Lavabo à poser en Tekno Deimos Bianco, Tekno Colore et Ecopietra. Y compris bonde S&G dans la finition. Éléments sous lavabo min. L 60 cm

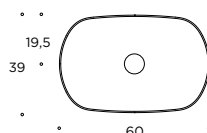

> Art. **A755** Tekno Deimos Bianco / Tekno Colore  
> Art. **A756** ECOPIETRA





## ALMOND 41

Tekno Deimos - Tekno Colore

Lavabo tutto fuori in Tekno Deimos Bianco e Tekno Colore.  
Per basi portalavabo min. L 50 cm

Countertop washbasin in Tekno Deimos Bianco and Tekno Colore.  
Washbasin units min. W 50 cm

Lavabo à poser en Tekno Deimos Bianco et Tekno Colore.  
Éléments sous lavabo min. L 50 cm

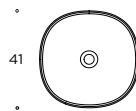

> Art. **ROOL**

tek. deimos  
**Bianco**

tekno  
**Colore**



## ALMOND 54

Tekno Deimos - Tekno Colore

Lavabo tutto fuori in Tekno Deimos Bianco e Tekno Colore.  
Per basi portalavabo min. L 60 cm

Countertop washbasin in Tekno Deimos Bianco and Tekno Colore.  
Washbasin units min. W 60 cm

Lavabo à poser en Tekno Deimos Bianco et Tekno Colore.  
Éléments sous lavabo min. L 60 cm

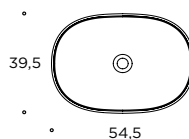

> Art. **ROOK**

tek. deimos  
**Bianco**

tekno  
**Colore**



## SWING

Tekno Deimos

Lavabo Tutto Fuori in Tekno Deimos Bianco. Compreso tappo copri piletta.  
Per basi portalavabo min. L 60 cm

Countertop washbasin in Tekno Deimos Bianco. Includes plug cover.  
Washbasin units min. W 60 cm

Lavabo à poser en Tekno Deimos Bianco. Comprend le couvre-bonde.  
Éléments sous lavabo min. L 60 cm

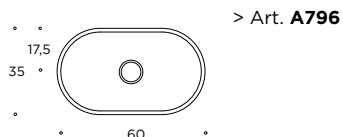

tek. deimos  
Bianco



## EGG

Tekno Deimos - Tekno Colore

Lavabo Tutto Fuori in Tekno Deimos Bianco e Tekno Colore. Compreso tappo copri piletta. Per basi portalavabo min. L 60 cm

Countertop washbasin in Tekno Deimos Bianco and Tekno Colore. Includes plug cover. Washbasin units min. W 60 cm

Lavabo à poser en Tekno Deimos Bianco et Tekno Colore. Comprend le couvre-bonde. Éléments sous lavabo min. L 60 cm

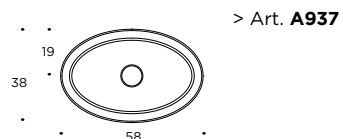

tek. deimos  
Bianco

tekno  
Colore



## KING

Tekno Deimos - Tekno Colore

Lavabo tutto fuori in Tekno Deimos Bianco e Tekno Colore.  
Per basi portalavabo min. L 50 cm

Countertop washbasin in Tekno Deimos Bianco and Tekno Colore.  
Washbasin units min. W 50 cm

Lavabo à poser en Tekno Deimos Bianco et Tekno Colore.  
Éléments sous lavabo min. L 50 cm

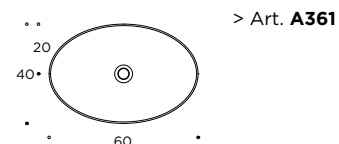

tek. deimos  
Bianco

tekno  
Colore



## SEMISFERA

Tekno Deimos - Tekno Colore

Lavabo tutto fuori in Tekno Deimos Bianco e Tekno Colore.  
Per basi portalavabo min. L 50 cm

Countertop washbasin in Tekno Deimos Bianco and Tekno Colore.  
Washbasin units min. W 50 cm

Lavabo à poser en Tekno Deimos Bianco et Tekno Colore.  
Éléments sous lavabo min. L 50 cm

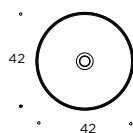

> Art. **A360**

tek. deimos  
**Bianco**

tekno  
**Colore**



## UP

Ceramica / Ceramic / Céramique  
Malta Ceramica/ Malta Ceramic/ Malta Céramique

Lavabo tutto fuori in Ceramica e Malta Ceramica.  
Per basi portalavabo min. L 50 cm

Countertop washbasin in Ceramic and Malta Ceramic.  
Washbasin units min. W 50 cm

Lavabo à poser en Céramique et Malta Céramique.  
Éléments sous lavabo min. L 50 cm

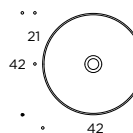

> Art. **A290**

Bianco  
lucido

malta c.  
Piombino

malta c.  
Sabbia



## PANIER 56

Ceramica / Ceramic / Céramique  
Malta Ceramica/ Malta Ceramic/ Malta Céramique

Lavabo tutto fuori in Ceramica e Malta Ceramica. Compresa piletta S&G in  
finitura. Per basi portalavabo min. L 60 cm

Countertop washbasin in Ceramic and Malta Ceramic. Including S&G drain in  
matching finish. Washbasin units min. W 60 cm

Lavabo à poser en Céramique et Malta Céramique. Y compris bonde S&G dans la  
finition. Éléments sous lavabo min. L 60 cm

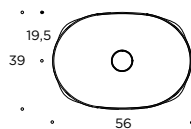

> Art. **A484**

**Bianco opaco/ matt/ mat**

> Art. **A184**

**Bianco lucido/ gloss/ brillant - Malta Ceramica**

ceramica  
**Bianco**

malta c.  
Piombino

malta c.  
Sabbia



## SOFFICE OUT

Ceramica / Ceramic / Céramique

Lavabo tutto fuori in Ceramica. Per basi portalavabo min. L 50 cm  
 Countertop washbasin in Ceramic. Washbasin units min. W 50 cm  
 Lavabo à poser en Céramique. Éléments sous lavabo min. L 50 cm

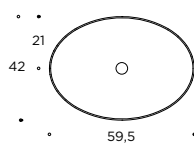

> Art. A451



## SMART 38

Ceramica / Ceramic / Céramique

Lavabo tutto fuori in Ceramica. Per basi portalavabo min. L 50 cm  
 Countertop washbasin in Ceramic. Washbasin units min. W 50 cm  
 Lavabo à poser en Céramique. Éléments sous lavabo min. L 50 cm

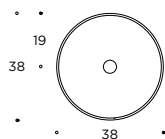

> Art. R009



## SMART 54

Ceramica / Ceramic / Céramique

Lavabo tutto fuori in Ceramica. Per basi portalavabo min. L 50 cm  
 Countertop washbasin in Ceramic. Washbasin units min. W 50 cm  
 Lavabo à poser en Céramique. Éléments sous lavabo min. L 50 cm

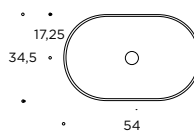

> Art. R00A



SOFFICE OUT  
Fard lucido

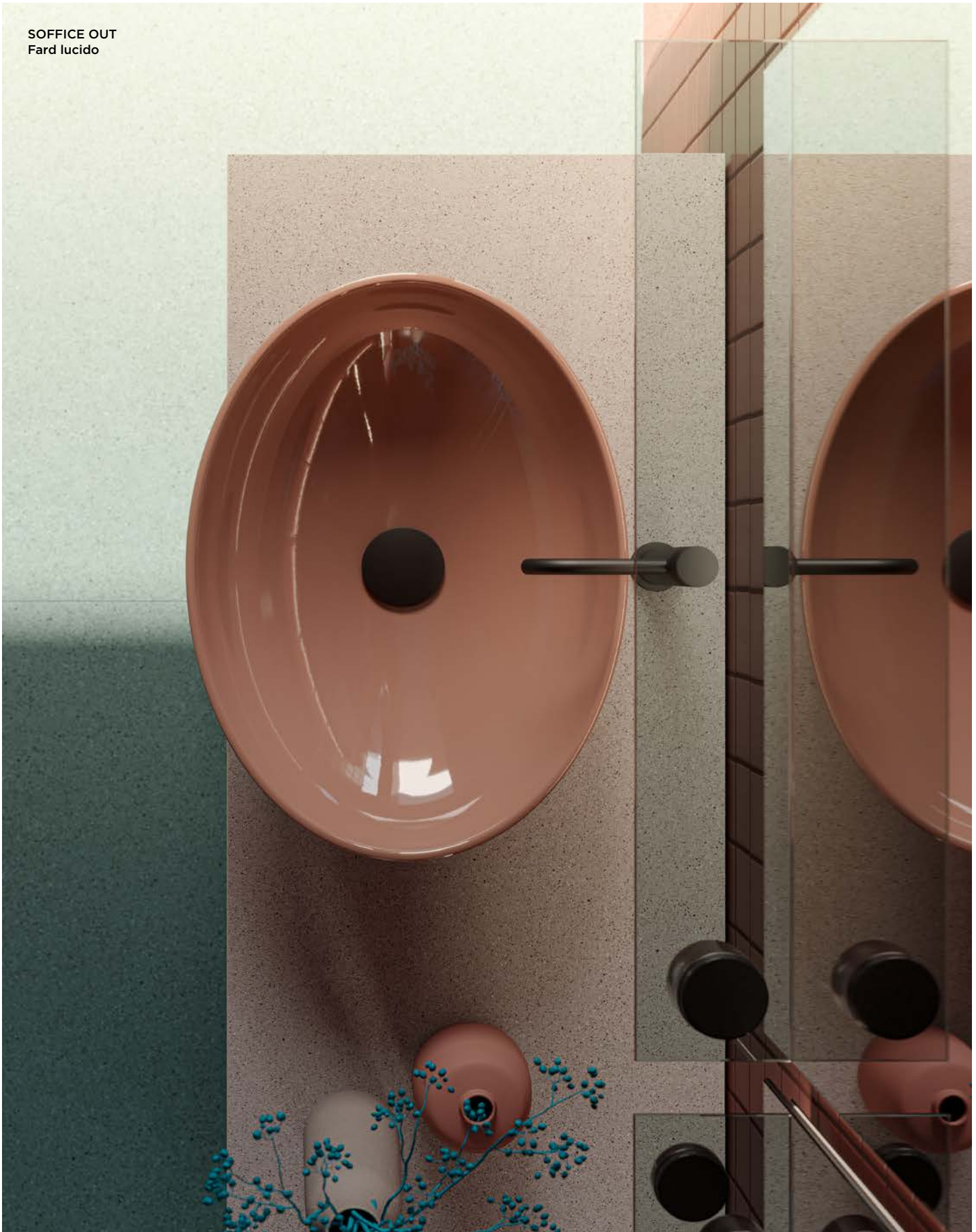



BOXY 38  
ceramica opaca



**BOXY 55**



**BOXY 38**



## BOXY 38

Ceramica / Ceramic / Céramique

Lavabo tutto fuori in Ceramica. Per basi portalavabo min. L 50 cm  
 Countertop washbasin in Ceramic. Washbasin units min. W 50 cm  
 Lavabo à poser en Céramique. Éléments sous lavabo min. L 50 cm

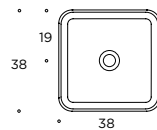

> Art. **R01D**

Bianco  
lucido

Bianco  
opaco



## BOXY 55

Ceramica / Ceramic / Céramique

Lavabo tutto fuori in Ceramica. Per basi portalavabo min. L 60 cm  
 Countertop washbasin in Ceramic. Washbasin units min. W 60 cm  
 Lavabo à poser en Céramique. Éléments sous lavabo min. L 60 cm

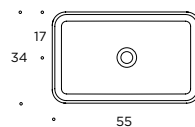

> Art. **R01E**

Bianco  
lucido

Bianco  
opaco



## FINE 42

Ceramica / Ceramic / Céramique

Lavabo tutto fuori in Ceramica. Per basi portavavabo min. L 50 cm

Countertop washbasin in Ceramic. Washbasin units min. W 50 cm

Lavabo à poser en Céramique. Éléments sous lavabo min. L 50 cm

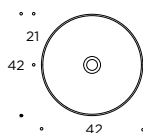

> Art. A511

Bianco  
lucido



## FINE 50

Ceramica / Ceramic / Céramique

Lavabo tutto fuori in Ceramica. Per basi portavavabo min. L 60 cm

Countertop washbasin in Ceramic. Washbasin units min. W 60 cm

Lavabo à poser en Céramique. Éléments sous lavabo min. L 60 cm

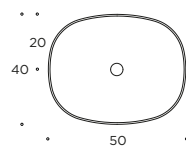

> Art. R01A

Bianco  
lucido



## FINE 60

Ceramica / Ceramic / Céramique

Lavabo tutto fuori in Ceramica. Per basi portavavabo min. L 60 cm

Countertop washbasin in Ceramic. Washbasin units min. W 60 cm

Lavabo à poser en Céramique. Éléments sous lavabo min. L 60 cm

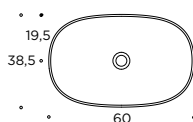

> Art. A289

Bianco  
lucido



## CIOTOLINA

Ceramica / Ceramic / Céramique

Lavabo tutto fuori in Ceramica. Per basi portavavabo min. L 50 cm

Countertop washbasin in Ceramic. Washbasin units min. W 50 cm

Lavabo à poser en Céramique. Éléments sous lavabo min. L 50 cm

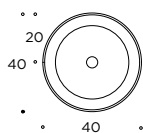

> Art. A344

Bianco  
lucido



## GHOST

Ceramica / Ceramic / Céramique

Lavabo tutto fuori in Ceramica. Per basi portalavabo min. L 60 cm

Countertop washbasin in Ceramic. Washbasin units min. W 60 cm

Lavabo à poser en Céramique. Éléments sous lavabo min. L 60 cm

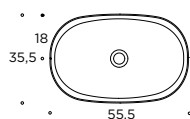

> Art. **A288**

Bianco  
lucido



## FOFFY

Ceramica / Ceramic / Céramique

Lavabo tutto fuori in Ceramica. Per basi portalavabo min. L 50 cm

Countertop washbasin in Ceramic. Washbasin units min. W 50 cm

Lavabo à poser en Céramique. Éléments sous lavabo min. L 50 cm

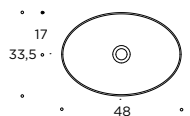

> Art. **A654**

Bianco  
lucido



## SOFFICE IN

Ceramica / Ceramic / Céramique

Lavabo tutto fuori in Ceramica. Per basi portalavabo min. L 50 cm

Countertop washbasin in Ceramic. Washbasin units min. W 50 cm

Lavabo à poser en Céramique. Éléments sous lavabo min. L 50 cm

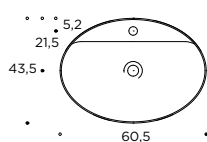

> Art. **A452**

Bianco  
lucido



## PANIER 42

Ceramica / Ceramic / Céramique

Lavabo tutto fuori in Ceramica. Per basi portalavabo min. L 50 cm

Countertop washbasin in Ceramic. Washbasin units min. W 50 cm

Lavabo à poser en Céramique. Éléments sous lavabo min. L 50 cm

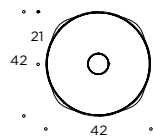

> Art. **A183**

> Art. **A483**

lucido / gloss / brillante

opaco / matt / mat

Bianco  
lucido

Bianco  
opaco



## COVER

Ceramica / Ceramic / Céramique

Lavabo tutto fuori in Ceramica. Per basi portlavabo min. L 60 cm

Countertop washbasin in Ceramic. Washbasin units min. W 60 cm

Lavabo à poser en Céramique. Éléments sous lavabo min. L 60 cm

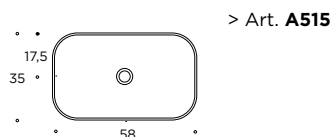

Bianco  
lucido



## ALICE

Ceramica / Ceramic / Céramique

Lavabo tutto fuori in Ceramica. Per basi portlavabo min. L 70 cm

Countertop washbasin in Ceramic. Washbasin units min. W 70 cm

Lavabo à poser en Céramique. Éléments sous lavabo min. L 70 cm

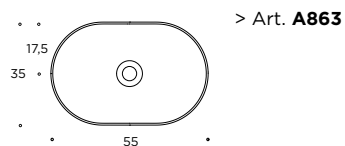

Bianco  
lucido



## AURORA

Ceramica / Ceramic / Céramique

Lavabo tutto fuori in Ceramica. Per basi portlavabo min. L 60 cm

Countertop washbasin in Ceramic. Washbasin units min. W 60 cm

Lavabo à poser en Céramique. Éléments sous lavabo min. L 60 cm

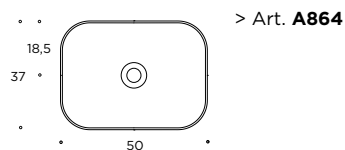

Bianco  
lucido



## COMFORT

Ceramica / Ceramic / Céramique

Lavabo tutto fuori in Ceramica con foro per troppo pieno.  
Per basi portlavabo min. L 60 cm

Countertop washbasin in Ceramic with overflow hole.  
Washbasin units min. W 60 cm

Lavabo à poser en Céramique avec trou pour trop-plein.  
Éléments sous lavabo min. L 60 cm

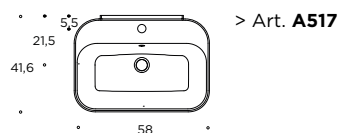

Bianco  
lucido

DELTA 60



## DELTA 60

Ceramica / Ceramic / Céramique

Lavabo tutto fuori in Ceramica con foro per troppo pieno.  
Per basi portalavabo min. L 70 cm

Countertop washbasin in Ceramic with overflow hole.  
Washbasin units min. W 70 cm

Lavabo à poser en Céramique avec trou pour trop-plein.  
Éléments sous lavabo min. L 70 cm

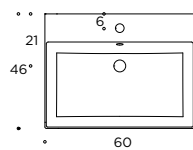

> Art. **A353**

Bianco  
lucido



## WONDER 60

Ceramica / Ceramic / Céramique

Lavabo tutto fuori in Ceramica con foro per troppo pieno.  
Per basi portalavabo min. L 70 cm

Countertop washbasin in Ceramic with overflow hole.  
Washbasin units min. W 70 cm

Lavabo à poser en Céramique avec trou pour trop-plein.  
Éléments sous lavabo min. L 70 cm

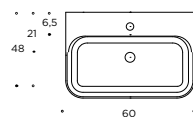

> Art. **A342**

Bianco  
lucido



WHISKY 45



WHISKY 53



## WHISKY 45

Ceramica / Ceramic / Céramique

Lavabo tutto fuori in Ceramica. Per basi portalavabo min. L 50 cm  
 Countertop washbasin in Ceramic. Washbasin units min. W 50 cm  
 Lavabo à poser en Céramique. Éléments sous lavabo min. L 50 cm

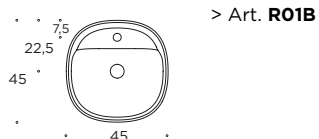

> Art. **R01B**

Bianco  
lucido



## WHISKY 53

Ceramica / Ceramic / Céramique

Lavabo tutto fuori in Ceramica. Per basi portalavabo min. L 60 cm  
 Countertop washbasin in Ceramic. Washbasin units min. W 60 cm  
 Lavabo à poser en Céramique. Éléments sous lavabo min. L 60 cm

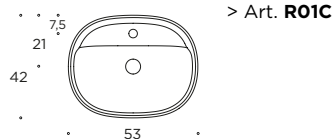

> Art. **R01C**

Bianco  
lucido



## PRETTY 60

Ceramica / Ceramic / Céramique

Lavabo semincasso in Ceramica. Per basi port lavabo min. L 70 cm

Semi-recessed washbasin in Ceramic. Washbasin units min. W 70 cm

Lavabo semi-encastéré en Céramique. Éléments sous lavabo min. L 70 cm

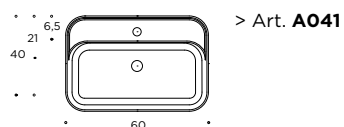

Bianco  
lucido



## NICE 60

Ceramica / Ceramic / Céramique

Lavabo incasso soprapiano in Ceramica. Per basi port lavabo min. L 70 cm

Overtop built-in washbasin in Ceramic. Washbasin units min. W 70 cm

Lavabo encastrés sur plan en céramique. Éléments sous lavabo min. L 70 cm

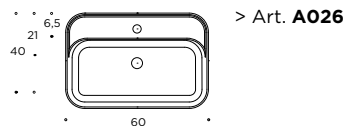

Bianco  
lucido



## DANDY

Ceramica / Ceramic / Céramique

Lavabo incasso soprapiano in Ceramica. Per basi port lavabo min. L 70 cm

Overtop built-in washbasin in Ceramic. Washbasin units min. W 70 cm

Lavabo encastrés sur plan en céramique. Éléments sous lavabo min. L 70 cm

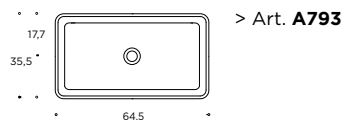

Bianco  
lucido



## BELT INC

Tekno Deimos

Lavabo incasso soprapiano in Tekno Deimos. Compresa piletta S&G in tekno.  
Per basi portalavabo min. L 70 cm

Overtop built-in washbasin in Tekno Deimos. Includes S&G plug in tekno.  
Washbasin units min. W 70 cm

Lavabo encastrés sur plan en Tekno Deimos. Avec bonde S&G en tekno.  
Éléments sous lavabo min. L 70 cm



tek. deimos  
Bianco



## LISA

Tekno Deimos - Tekno Colore

Lavabo incasso soprapiano in Tekno Deimos Bianco e Tekno Colore. Compreso  
tappo copripiletta. Per basi portalavabo min. L 70 cm

Overtop built-in washbasin in Tekno Deimos Bianco and Tekno Colore. Includes  
plug cover. Washbasin units min. W 70 cm

Lavabo encastrés sur plan en Tekno Deimos Bianco et Tekno Colore. Avec cache  
bonde. Éléments sous lavabo min. L 70 cm

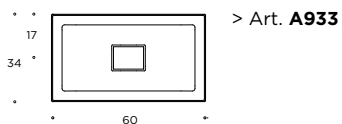

tek. deimos  
Bianco

tekno  
Colore



## EGG INC

Tekno Deimos - Tekno Colore

Lavabo incasso soprapiano in Tekno Deimos Bianco e Tekno Colore. Compreso  
tappo copripiletta. Per basi portalavabo min. L 70 cm

Overtop built-in washbasin in Tekno Deimos Bianco and Tekno Colore. Includes  
plug cover. Washbasin units min. W 70 cm

Lavabo encastrés sur plan en Tekno Deimos Bianco et Tekno Colore. Avec cache  
bonde. Éléments sous lavabo min. L 70 cm

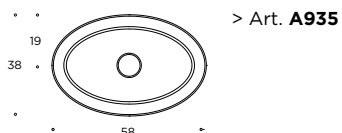

tek. deimos  
Bianco

tekno  
Colore

LISA  
Tekno Deimos bianco





IGLOO RETTANGOLARE 60  
Tekno colore Rosso Casale



## IGLOO OVALE 48

Lavabo sottopiano in tekno deimos bianco e tekno colore.  
Per basi portalavabo min. L 60 cm

Undercounter washbasin in tekno deimos bianco and tekno color.  
Washbasin units min. W 60 cm

Lavabo sous-plan en tekno deimos bianco et tekno couleur.  
Éléments sous lavabo min. L 60 cm

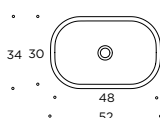

> Art. **R013**

tek. deimos  
**Bianco**

tekno  
**Colore**



## IGLOO OVALE 60

Lavabo sottopiano in tekno deimos bianco e tekno colore.  
Per basi portalavabo min. L 70 cm

Undercounter washbasin in tekno deimos bianco and tekno color.  
Washbasin units min. W 70 cm

Lavabo sous-plan en tekno deimos bianco et tekno couleur.  
Éléments sous lavabo min. L 70 cm

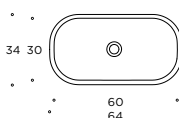

> Art. **R014**

tek. deimos  
**Bianco**

tekno  
**Colore**



## IGLOO RETTANGOLARE 48

Lavabo sottopiano in tekno deimos bianco e tekno colore.  
Per basi portalavabo min. L 60 cm

Undercounter washbasin in tekno deimos bianco and tekno color.  
Washbasin units min. W 60 cm

Lavabo sous-plan en tekno deimos bianco et tekno couleur.  
Éléments sous lavabo min. L 60 cm

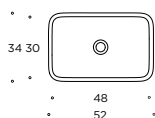

> Art. **R011**

tek. deimos  
**Bianco**

tekno  
**Colore**



## IGLOO RETTANGOLARE 60

Lavabo sottopiano in tekno deimos bianco e tekno colore.  
Per basi portalavabo min. L 70 cm

Undercounter washbasin in tekno deimos bianco and tekno color.  
Washbasin units min. W 70 cm

Lavabo sous-plan en tekno deimos bianco et tekno couleur.  
Éléments sous lavabo min. L 70 cm

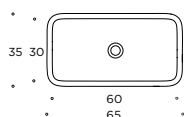

> Art. **R012**

tek. deimos  
**Bianco**

tekno  
**Colore**



## ROMAN BASSO

Tekno Deimos

Lavabo tutto fuori in tekno deimos. Compresa piletta Scarico libero in tekno deimos. Per basi portalavabo min. L 50 cm

Washbasin countertop in Tekno Deimos. Includes plug and drain pipe in Tekno Deimos. For washbasin bases min. W 50 cm.

Lavabo à poser en tekno deimos. Bonde évacuation libre en tekno deimos. Utilisation pour éléments sous-lavabo min. L 50

> Art. **AA05**

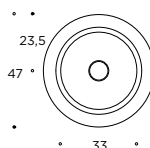

tek. deimos  
Bianco



## ROMAN MEDIO

Tekno Deimos

Lavabo tutto fuori in tekno deimos. Compresa piletta Scarico libero in tekno deimos. Per basi portalavabo min. L 50 cm

Washbasin countertop in Tekno Deimos. Includes plug and drain pipe in Tekno Deimos. For washbasin bases min. W 50 cm.

Lavabo à poser en tekno deimos. Bonde évacuation libre en tekno deimos. Utilisation pour éléments sous-lavabo min. L 50

> Art. **AA06**

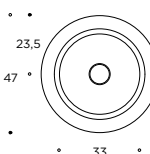

tek. deimos  
Bianco



## ROMAN ALTO

Tekno Deimos

Lavabo in tekno deimos. Compresa piletta Scarico libero in tekno deimos.

Washbasin in Tekno Deimos. Including drain. Free drain in Tekno Deimos.

Lavabo en tekno deimos. Bonde évacuation libre en tekno deimos.

> Art. **AA07**

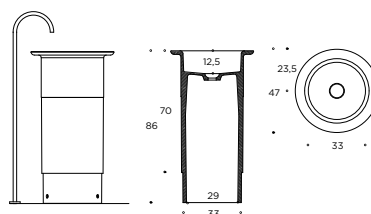

tek. deimos  
Bianco



## ERCOLE

Ocritech

Lavabo tutto fuori in Ocritech H 12 cm. Con ripiano e foro per rubinetto  
 Countertop washbasin in Ocritech H 12 cm. With shelf and tap hole  
 Lavabo à poser en Ocritech H 12 cm. Avec tablette et trou pour robinet

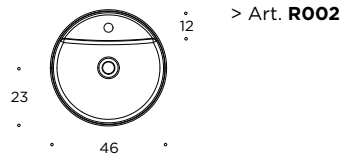

ocritech  
Bianco



## ERCOLE

Ocritech

Lavabo tutto fuori in Ocritech H 12 cm. Con ripiano  
 Countertop washbasin in Ocritech H 12 cm. With shelf  
 Lavabo à poser en Ocritech H 12 cm. Avec tablette

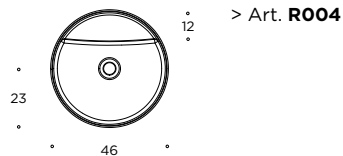

ocritech  
Bianco



## ERCOLE

Ocritech - Acrilico / Acrylic / Acrylique

Lavabo tutto fuori in ocritech o acrilico H 12 cm.  
 Tutto Fuori washbasin in ocritech or acrylic H 12 cm.  
 Lavabo à poser en ocritech ou acrylique H 12 cm.

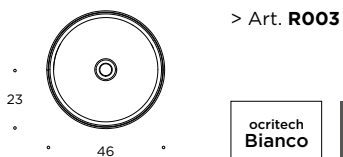

ocritech Bianco    acrilico Grigio    acrilico Bronzo    acrilico Verde    acrilico Rosso



## KALI

Tekno Deimos - Tekno Colore

Lavabo KALI CENTROSTANZA tekno e tekno colore.  
Compresa piletta scarico libero in tekno.

KALI INDIPENDET washbasin tekno and tekno color.  
Included plug free drain in tekno.

Lavabo KALI ÎLOT tekno et tekno coloris.  
Bonde évacuation libre en tekno.

- > Art. **AA08** (bianco)
- > Art. **AB13** (colore esterno)
- > Art. **AA08** (tutto colore)

tek. deimos  
**Bianco**

tekno  
**Colore**

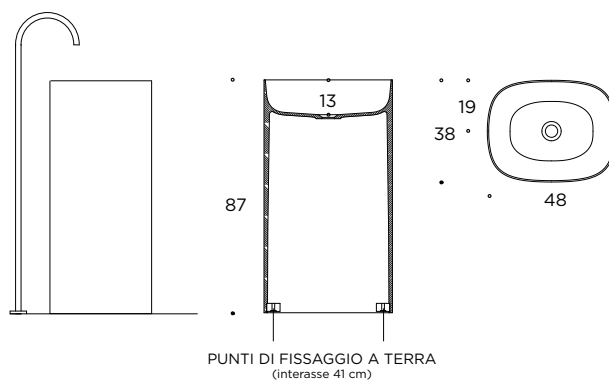

## KALI

Tekno Deimos - Tekno Colore

Lavabo KALI CENTROSTANZA tekno e tekno colore, con foro per rubinetto e troppo pieno.  
Compresa piletta scarico libero in tekno.

KALI INDIPENDET washbasin tekno and tekno color, with tap hole and overflow.  
Included plug free drain in tekno.

Lavabo KALI ÎLOT tekno et tekno coloris, avec trou pour robinet et trop plein.  
Bonde évacuation libre en tekno.

- > Art. **R005** (bianco)
- > Art. **R007** (colore esterno)
- > Art. **R005** (tutto colore)

tek. deimos  
**Bianco**

tekno  
**Colore**

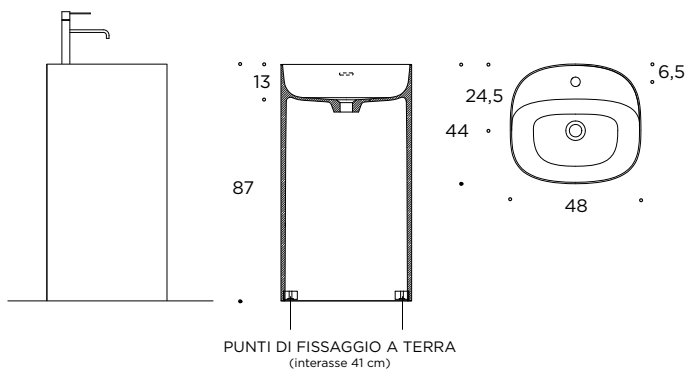



## KALI A MURO

Tekno Deimos - Tekno Colore

tek. deimos  
**Bianco**

tekno  
**Colore**

Lavabo KALI A MURO tekno e tekno colore.  
Compresa piletta scarico libero in tekno.

KALI WALL-MOUNTED washbasin tekno  
and tekno color. Included drain plug  
free drain in tekno.

Lavabo KALI MURAL tekno et tekno coloris.  
Bonde évacuation libre en tekno.

- > Art. **AA17** (bianco)
- > Art. **AB14** (colore esterno)
- > Art. **AA17** (tutto colore)

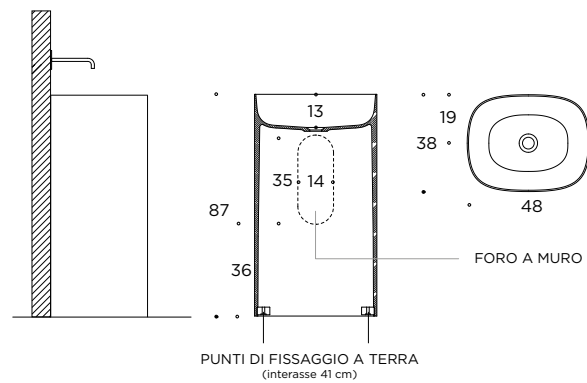

## KALI A MURO

Tekno Deimos - Tekno Colore

tek. deimos  
**Bianco**

tekno  
**Colore**

Lavabo KALI A MURO tekno e tekno colore,  
con foro per rubinetto e troppo pieno.  
Compresa piletta scarico libero in tekno.

KALI WALL-MOUNTED washbasin tekno  
and tekno color, with tap hole and overflow.  
Included plug with free drain in tekno.

Lavabo KALI MURAL tekno et tekno coloris,  
avec trou pour robinet et trop-plein.  
Bonde évacuation libre en tekno.

- > Art. **R006** (bianco)
- > Art. **R008** (colore esterno)
- > Art. **R006** (tutto colore)

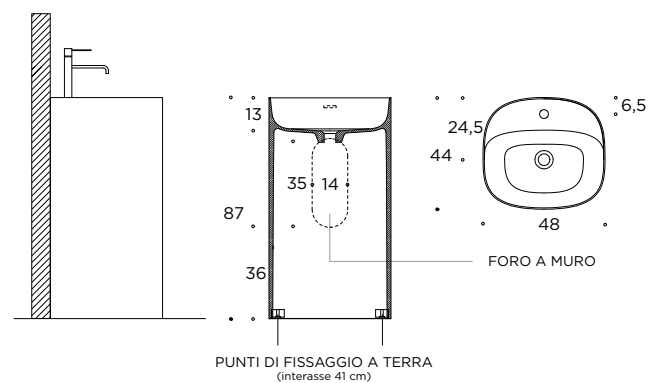



ULISSE  
Gres Iris Marsala



# ULISSE

Laminam - Gres

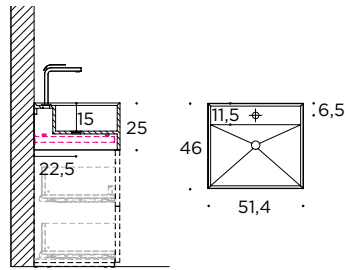

Lavabo ULISSE con foro per rubinetto.  
 Impiego solo in appoggio su base L 51,2 x H 62 x P 45,7 cm

ULISSE Washbasin with tap hole.  
 Use only resting on base W 51.2 x H 62 x D 45.7 cm

Lavabo ULISSE avec trou pour robinet.  
 Utilisation uniquement à poser sur base L 51,2 x H 62 x P 45,7 cm

> Art. **ROOH**



# ULISSE

Laminam - Gres

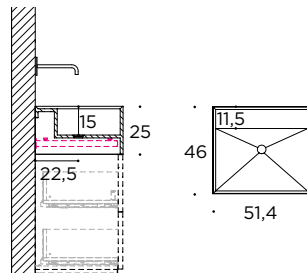

Lavabo ULISSE senza foro per rubinetto.  
 Impiego solo in appoggio su base L 51,2 x H 62 x P 45,7 cm

ULISSE Washbasin without tap hole.  
 Use only resting on base W 51.2 x H 62 x D 45.7 cm

Lavabo ULISSE sans trou pour robinet.  
 Utilisation uniquement à poser sur base L 51,2 x H 62 x P 45,7 cm

> Art. **ROOI**

## CATEGORIA 5 LAMINAM GRES



Laminam  
AA Fokos Sale



Laminam  
AC Fokos Terra



Laminam  
AB Fokos Roccia



Laminam  
AD Fokos Piombo



Laminam  
AI Nero Greco



Laminam  
DV Ossido Nero



Laminam  
AF Pietra di S. Perla



Laminam  
AE Pietra di S. Grigia



Laminam  
AG Pietra di S. Antracite



Laminam  
DJ Calce Bianco



Laminam  
DW Ossido Bruno

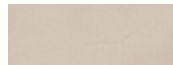

GRES Iris  
AJ Ivory

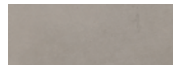

GRES Iris  
AL Silver



GRES Iris  
AM Amber

## CATEGORIA 6 LAMINAM GRES



Laminam  
DS Pietra di Cardoso  
Nero



Laminam  
D3 Terra di Matera



Laminam  
D4 Terra di Saturnia

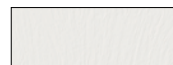

Laminam  
DQ Ardesia Spacco  
Bianco



Laminam  
DR Ardesia Spacco  
Nero



Laminam  
L1 Alaska



Laminam  
L3 Ankara



Laminam  
L2 Amazzonia



Laminam  
L0 Burgundy



Laminam  
L4 Vulcano



GRES Iris  
D7 Marsala

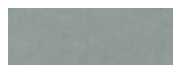

GRES Iris  
D8 Azure



GRES Iris  
D9 Steel Blue



GRES Iris  
D6 Green



## GURU 70

Ocritech

**Lavabo incasso H 12,2 cm con foro per rubinetto e scivolo removibile.**

Semi-recessed washbasin H 12.2 cm with tap hole and removable slide.

Lavabo encastrés H 12,2 cm avec trou pour robinet et glissière amovible.

> Art. **RO1F**

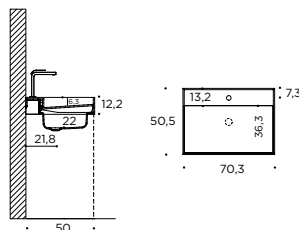

Ocritech  
Bianco



## GURU 85

Ocritech

**Lavabo incasso dx-sx H 12,2 cm con foro per rubinetto e scivolo removibile.**

RHS-LHS semi-recessed washbasin H 12.2 cm with tap hole and removable slide.

Lavabo encastrés droite - gauche H 12,2 cm avec trou pour robinet et glissière amovible.

> Art. **RO1G**

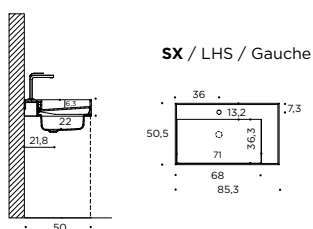

Ocritech  
Bianco



## GURU 70

Ocritech

**Lavabo incasso H 26,5 cm con foro per rubinetto e scivolo removibile.**

Semi-recessed washbasin H 26.5 cm with tap hole and removable slide.

Lavabo encastrés H 26,5 cm avec trou pour robinet et glissière amovible.

> Art. **AA11**

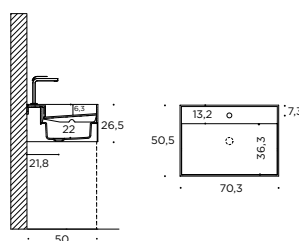

Ocritech  
Bianco



## GURU 85

Ocritech

**Lavabo incasso dx-sx H 26,5 cm con foro per rubinetto e scivolo removibile.**

RHS-LHS semi-recessed washbasin H 26.5 cm with tap hole and removable slide.

Lavabo encastrés droite - gauche H 26,5 cm avec trou pour robinet et glissière amovible.

> Art. **AA12**

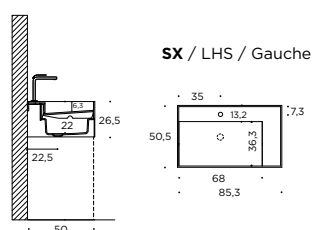

Ocritech  
Bianco

GURU 85  
Ocritch Bianco



# FINITURE LAVABI SARTORIALI / CUSTOM WASHBASINS FINISHES/ FINITIONS LAVABOS DE COUTURIER

## CORIAN



Corian  
C1 Bianco opaco

## CATEGORIA 5 LAMINAM GRES



Laminam  
AA Fokos Sale



Laminam  
AC Fokos Terra



Laminam  
AB Fokos Roccia



Laminam  
AD Fokos Piombo



Laminam  
AI Nero Greco



Laminam  
AV Pietra Grey



Laminam  
AF Pietra di S. Perla



Laminam  
AE Pietra di S. Grigia



Laminam  
AG Pietra di S. Antracite



Laminam  
DJ Calce Bianco



Laminam  
DW Ossido Bruno



Laminam  
DV Ossido Nero



GRES Iris  
AJ Ivory

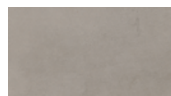

GRES Iris  
AL Silver



GRES Iris  
AM Amber

## CATEGORIA 6 LAMINAM GRES



Laminam  
DO Bianco Assoluto  
opaco



Laminam  
DM Pietra Piasentina



Laminam  
DN Calacatta Oro  
Venato



Laminam  
DO Bianco Statuario  
Venato

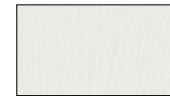

Laminam  
DQ Ardesia Spacco  
Bianco



Laminam  
DR Ardesia Spacco  
Nero

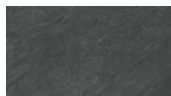

Laminam  
DS Pietra di Cardoso  
Nero



Laminam  
DT Pietra di Cardoso  
Grigio



GRES  
DX Iseo Abujardado



GRES  
DY Azalai Negro



Laminam  
AX Statuarietto

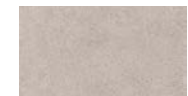

Laminam  
D3 Terra di Matera



Laminam  
D4 Terra di Saturnia



GRES Iris  
D7 Marsala



GRES Iris  
D8 Azure



GRES Iris  
D9 Steel Blue



GRES Iris  
D6 Green

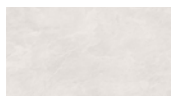

Laminam  
L1 Alaska

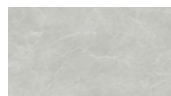

Laminam  
L3 Ankara

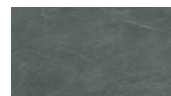

Laminam  
L2 Amazonia



Laminam  
LO Burgundy

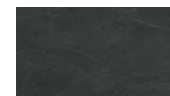

Laminam  
L4 Vulcano

## CATEGORIA 7 LAMINAM LUCIDO



Laminam  
AY Noir Desir  
Lucido



Laminam  
D5 Verde Alpi  
Lucido



Se non specificato il piano top verrà realizzato con un foro rubinetto posteriore centrale (fino a L 140) o due fori rubinetto posteriori (da 141 a 170)

If not specified, the top will be made with a central rear tap hole (up to W. 140) or two rear tap holes (from 141 to 170).

Si non spécifié, le plan de toilette sera réalisé avec un trou pour robinet arrière central (jusqu'à L 140) ou deux trous arrière (de 141 à 170)

## UNIQUE

Laminam - Gres

Piano top sp. 18,5 x L max 170 x P 37 cm.

Vasca interna L (lunghezza totale piano - 2,4 cm) x P 26,5 x H 7,5 cm.

Top thickness 18.5 x max. length 170 x depth 37 cm.

Internal basin L. (total top length - 2.4 cm) x D. 26.5 x H. 7.5 cm.

Plateau ép. 18,5 x L max 170 x P 37 cm.

Cuve interne L (longueur totale plateau - 2,4 cm) x P 26,5 x H 7,5 cm.

Lunghezza piano (da - a) / Top lenght (from - to) / Longueur plateau (de - à )

> Art. **F189** 70 - 105

> Art. **F289** 106 - 140

> Art. **F389** 141 - 170

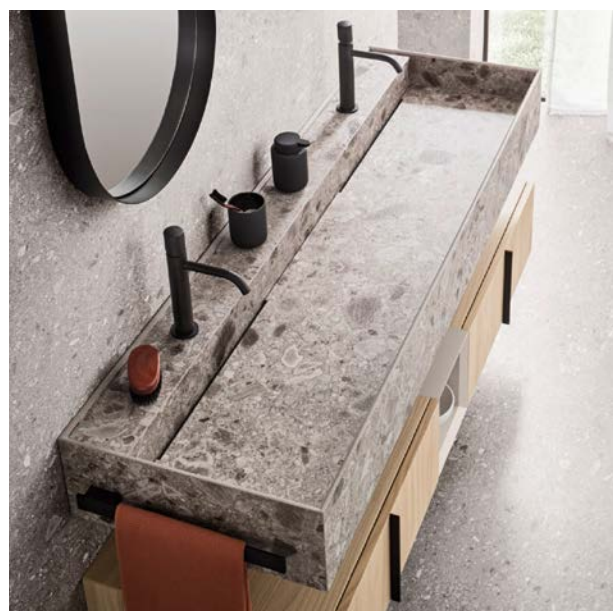
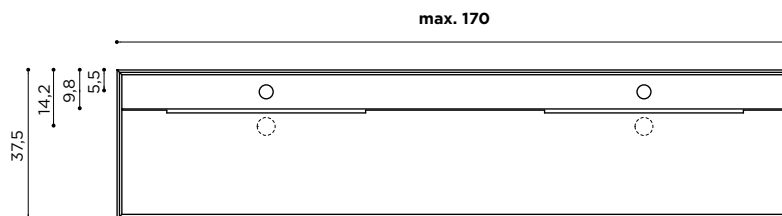

Se non specificato il piano top verrà realizzato con un foro rubinetto posteriore centrale (fino a L 140) o due fori rubinetto posteriori (da 141 a 170)

If not specified, the top will be made with a central rear tap hole (up to W. 140) or two rear tap holes (from 141 to 170).

Si non spécifié, le plan de toilette sera réalisé avec un trou pour robinet arrière central (jusqu'à L 140) ou deux trous arrière (de 141 à 170)

## FREE

Laminam - Gres

Piano top sp. 18,5 x L max 170 x P 50 cm.

Vasca interna L (lunghezza totale piano - 2,4 cm) x P 36 x H 7,5 cm.

Top thickness 18.5 x max. length 170 x depth 50 cm.

Internal basin L. (total top length - 2.4 cm) x D. 36 x H. 7.5 cm.

Plateau ép. 18,5 x L max 170 x P 50 cm.

Cuve interne L (longueur totale plateau - 2,4 cm) x P 36 x H 7,5 cm.

Lunghezza piano (da - a) / Top lenght (from - to) / Longueur plateau (de - à )

> Art. **F499** 70 - 105

> Art. **F599** 106 - 140

> Art. **F699** 141 - 170

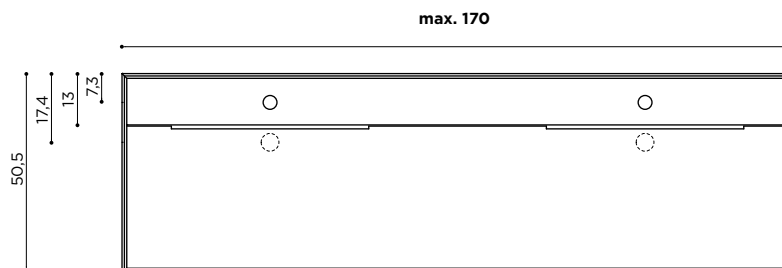

02. Lavabi / Washbasins / Lavabos



BUDDHA 105



BUDDHA 85



## BUDDHA 85

Corian - Laminam - Gres

Lavabo BUDDHA 85 dx-sx H 26,5 cm in appoggio con foro per rubinetto.  
L 85,3 x P 50,5 x H 26,5 cm (peso: 56 kg)

BUDDHA 85 washbasin right-left H 26.5 cm countertop with tap hole.  
W. 85.3 x D. 50.5 x H. 26.5 cm (weight: 56 kg)

Lavabo BUDDHA 85 droite-gauche H 26,5 cm à poser avec trou pour robinet.  
L 85,3 x P 50,5 x H 26,5 cm (poids : 56 kg)

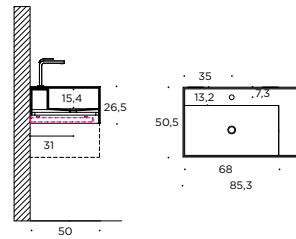

> Art. AA14



## BUDDHA 105

Corian - Laminam - Gres

Lavabo BUDDHA 105 dx-sx H 26,5 cm in appoggio con foro per rubinetto.  
L 105,3 x P 50,5 x H 26,5 cm (peso: 62 kg)

BUDDHA 105 washbasin right-left H 26.5 cm countertop with tap hole.  
W. 105.3 x D. 50.5 x H. 26.5 cm (weight: 62 kg)

Lavabo BUDDHA 105 droite-gauche H 26,5 cm à poser avec trou pour robinet.  
L 105,3 x P 50,5 x H 26,5 cm (poids : 62 kg)

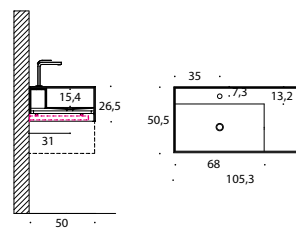

> Art. AA13



#### CORIAN

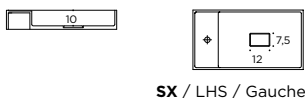

SX / LHS / Gauche

#### LAMINAM

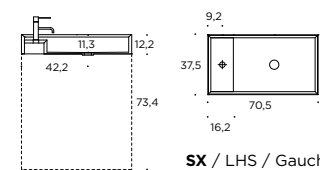

SX / LHS / Gauche

## MANTRA MINI

Corian - Laminam - Gres

Lavabo MANTRA MINI dx-sx H 12,2 in appoggio con foro per rubinetto. L 70,5 x P 37,5 x H 12,2 cm. Impiego solo in appoggio su basi L 70 x H 73,4 x P 37 cm

MANTRA MINI washbasin right-left H 12.2 countertop with tap hole. W 70.5 x D 37.5 x H 12.2 cm. Use only as a countertop on base units L 70 x H 73.4 x D 37 cm

Lavabo MANTRA MINI droite-gauche. H 12,2 à poser avec trou pour robinet. L 70,5 x P 37,5 x H 12,2 cm. Utilisation uniquement à poser sur éléments bas L 70 x H 73,4 x P 37 cm

> Art. **A946**



#### CORIAN

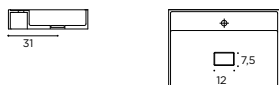

#### LAMINAM

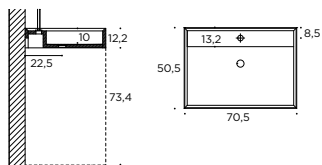

## MANTRA

Corian - Laminam - Gres

Lavabo MANTRA H 12,2 in appoggio con foro per rubinetto. L 70,5 x P 50,5 x H 12,2 cm. Impiego solo in appoggio su basi L 70 x H 73,4 x P 50 cm

MANTRA MINI washbasin right-left H 12.2 countertop with tap hole. W 70.5 x D 50.5 x H 12.2 cm. Use only as a countertop on base units L 70 x H 73.4 x D 50 cm

Lavabo MANTRA MINI droite-gauche. H 12,2 à poser avec trou pour robinet. L 70,5 x P 50,5 x H 12,2 cm. Utilisation uniquement à poser sur éléments bas L 70 x H 73,4 x P 50 cm

> Art. **A639**



#### CORIAN



#### LAMINAM

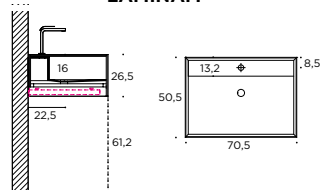

## MANTRA

Corian - Laminam - Gres

Lavabo MANTRA H 26,5 in appoggio con foro per rubinetto. L 70,5 x P 50,5 x H 26,5 cm. Impiego solo in appoggio.

MANTRA MINI washbasin right-left H 26.5 countertop with tap hole. W 70.5 x D 50.5 x H 26.5 cm. Use only as a countertop.

Lavabo MANTRA MINI droite-gauche. H 26,5 à poser avec trou pour robinet. L 70,5 x P 50,5 x H 26,5 cm. Utilisation uniquement à poser.

> Art. **AA24**

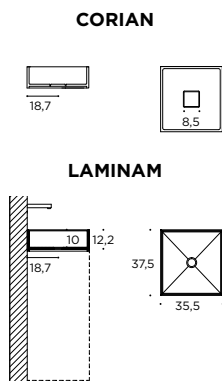

## KARMA 35

Corian - Laminam - Gres

Lavabo KARMA 35 in appoggio senza foro per rubinetto L 35,5 x P 37,5 x H 12,2 cm. Impiego per Monolite Code Art. LC81 o LC82 o piani P 50 cm

KARMA 35 countertop washbasin without tap hole W 35,5 x D 37,5 x H 12,2 cm. Use for Monolite Code Art. LC81 or LC82 or tops P 50 cm.

Lavabo KARMA 35 à poser sans trou pour robinet L 35,5 x P 37,5 x H 12,2 cm. Utilisation pour Monolite Code Art. LC81 ou LC82 ou plans P 50 cm

> Art. **A194**

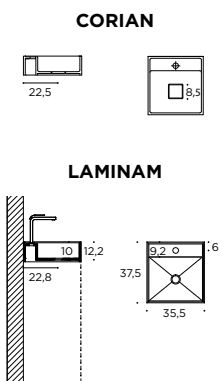

## KARMA 35

Corian - Laminam - Gres

Lavabo KARMA 35 in appoggio con foro per rubinetto L 35,5 x P 37,5 x H 12,2 cm. Impiego per Monolite Code Art. LC81 o LC82 o piani P 50 cm

KARMA 35 countertop washbasin with tap hole W 35,5 x D 37,5 x H 12,2 cm. Use for Monolite Code Art. LC81 or LC82 or tops P 50 cm.

Lavabo KARMA 35 à poser avec trou pour robinet L 35,5 x P 37,5 x H 12,2 cm. Utilisation pour Monolite Code Art. LC81 ou LC82 ou plans P 50 cm

> Art. **A195**

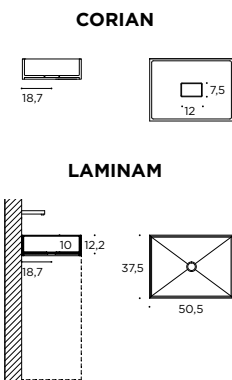

## KARMA 50

Corian - Laminam - Gres

Lavabo KARMA 50 in appoggio senza foro per rubinetto L 50,5 x P 37,5 x H 12,2 cm. Impiego per Monolite Code Art. LC83 o LC84 o piani P 50 cm

KARMA 50 countertop washbasin without tap hole W 50,5 x D 37,5 x H 12,2 cm. Use for Monolite Code Art. LC83 or LC84 or tops P 50 cm.

Lavabo KARMA 50 à poser sans trou pour robinet L 50,5 x P 37,5 x H 12,2 cm. Utilisation pour Monolite Code Art. LC83 ou LC84 ou plans P 50 cm

> Art. **AA15**

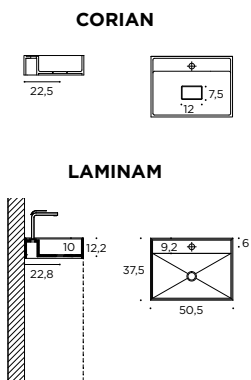

## KARMA 50

Corian - Laminam - Gres

Lavabo KARMA 50 in appoggio con foro per rubinetto L 50,5 x P 37,5 x H 12,2 cm. Impiego per Monolite Code Art. LC83 o LC84 o piani P 50 cm

KARMA 50 countertop washbasin with tap hole W 50,5 x D 37,5 x H 12,2 cm. Use for Monolite Code Art. LC83 or LC84 or tops P 50 cm.

Lavabo KARMA 50 à poser avec trou pour robinet L 50,5 x P 37,5 x H 12,2 cm. Utilisation pour Monolite Code Art. LC83 ou LC84 ou plans P 50 cm

> Art. **AA16**



ZEN  
Laminam Bianco Assoluto



**CORIAN**

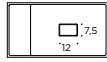

SX / LHS / Gauche

**LAMINAM**

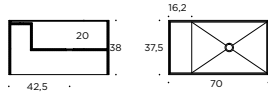

SX / LHS / Gauche

# TANTRA

Corian - Laminam - Gres

**Lavabo TANTRA dx-sx senza foro per rubinetto L 70 x P 37,5 x H 38 cm (peso GRES/LAMINAM: 41 kg - peso CORIAN: 25 kg)**

TANTRA washbasin right-left without tap hole W 70 x D 37.5 x H 38 cm (weight GRES/LAMINAM: 41 kg - weight CORIAN: 25 kg)

Lavabo TANTRA droite-gauche sans trou pour robinet L 70 x P 37,5 x H 38 cm (poids GRES/LAMINAM : 41 kg - poids CORIAN : 25 kg)

> Art. **A096**



**CORIAN**

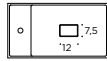

SX / LHS / Gauche

**LAMINAM**

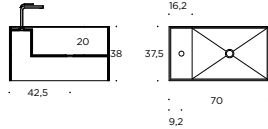

SX / LHS / Gauche

# TANTRA

Corian - Laminam - Gres

**Lavabo TANTRA dx-sx con foro per rubinetto laterale L 70 x P 37,5 x H 38 cm (peso GRES/LAMINAM: 41 kg - peso CORIAN: 25 kg)**

TANTRA washbasin right-left with side tap hole L 70 x D 37.5 x H 38 cm (weight GRES/LAMINAM: 41 kg - weight CORIAN: 25 kg)

Lavabo TANTRA droite-gauche avec trou pour robinet latéral L 70 x P 37,5 x H 38 cm (poids GRES/LAMINAM : 41 kg - poids CORIAN : 25 kg)

> Art. **A097**



**CORIAN**



**LAMINAM**

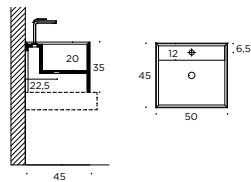

# ZEN H 35

Corian - Laminam - Gres

**Lavabo ZEN IN APPOGGIO con foro per rubinetto L 50 x P 45 x H 35 cm (peso GRES/LAMINAM: 38 kg - peso CORIAN: 19 kg)**

ZEN COUNTERTOP washbasin with tap hole W 50 x D 45 x H 35 cm (weight GRES/LAMINAM: 38 kg - weight CORIAN: 19 kg)

Lavabo ZEN À POSER avec trou pour robinet L 50 x P 45 x H 35 cm (poids GRES/LAMINAM : 38 kg - poids CORIAN : 19 kg)

> Art. **A643**



**CORIAN**

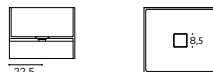

**LAMINAM**

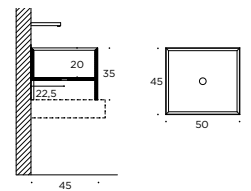

# ZEN H 35

Corian - Laminam - Gres

**Lavabo ZEN IN APPOGGIO per rubinetto a parete L 50 x P 45 x H 35 cm (peso GRES/LAMINAM: 38 kg - peso CORIAN: 18 kg)**

ZEN COUNTERTOP washbasin for wall-mounted tap W 50 x D 45 x H 35 cm (weight GRES/LAMINAM: 38 kg - weight CORIAN: 18 kg)

Lavabo ZEN À POSER pour robinet mural L 50 x P 45 x H 35 cm (poids GRES/LAMINAM : 38 kg - poids CORIAN : 18 kg)

> Art. **A644**

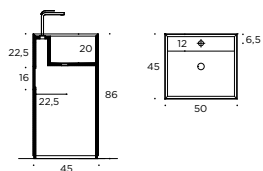

## ZEN

Laminam - Gres

Lavabo ZEN a terra CENTROSTANZA con foro rubinetto.  
L 50 x P 45 x H 86 cm (peso GRES/LAMINAM: 58 kg). Pannello posteriore asportabile.

ZEN floor-standing washbasin INDIPENDENT with tap hole  
W 50 x D 45 x H 86 cm (weight GRES/LAMINAM: 58 kg). Removable back panel.

Lavabo ZEN au sol ÎLOT avec trou pour robinet  
L 50 x P 45 x H 86 cm (poids GRES/LAMINAM : 58 kg). Panneau arrière amovible.

> Art. **A641**

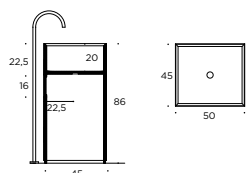

## ZEN

Laminam - Gres

Lavabo ZEN a terra CENTROSTANZA per rubinetto centrostanza.  
L 50 x P 45 x H 86 cm (peso GRES/LAMINAM: 55 kg). Pannello posteriore asportabile.

ZEN floor-standing washbasin INDIPENDENT for central tap.  
L 50 x D 45 x H 86 cm (weight GRES/LAMINAM: 55 kg). Removable back panel.

Lavabo ZEN au sol ÎLOT pour robinet centre de pièce. L 50 x P 45 x H 86 cm  
(poids GRES/LAMINAM : 55 kg). Panneau arrière amovible.

> Art. **A642**

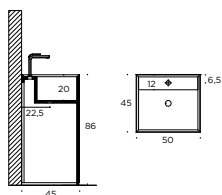

## ZEN

Laminam - Gres

Lavabo ZEN a terra APPOGGIO A MURO con foro rubinetto.  
L 50 x P 45 x H 86 cm (peso GRES/LAMINAM: 45 kg).

ZEN floor-standing washbasin WALL-MOUNTED with tap hole.  
W 50 x D 45 x H 86 cm (weight GRES/LAMINAM: 45 kg).

Lavabo ZEN au sol ADOSSÉ AU MUR avec trou pour robinet.  
L 50 x P 45 x H 86 cm (poids GRES/LAMINAM : 45 kg).

> Art. **A834**

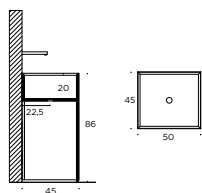

## ZEN

Laminam - Gres

Lavabo ZEN a terra APPOGGIO A MURO per rubinetto a parete.  
L 50 x P 45 x H 86 cm (peso GRES/LAMINAM: 45 kg).

ZEN floor-standing washbasin INDIPENDENT for central tap.  
L 50 x D 45 x H 86 cm (weight GRES/LAMINAM: 45 kg).

Lavabo ZEN au sol ÎLOT pour robinet centre de pièce. L 50 x P 45 x H 86 cm  
(poids GRES/LAMINAM : 45 kg).

> Art. **A835**



JUNO 121  
Tekno Bianco

03.

# CONSOLLE

---

CONSOLE  
CONSOLE

P/D  
37

## PAROS

Cristalplant



### PAROS 51

Cristalplant

Lavabo consolle in cristalplant H 1,5. Compresso tappo copripiletta. Impiego per basi portalavabo L 50 x P 37 cm.

Console washbasin in cristalplant H 1.5. Includes plug cover. Use for washbasin units W. 50 x D. 37 cm.

Lavabo consolle en cristalplant H 1,5. Comprend cache-bonde. Utilisation pour éléments sous-lavabo L 50 x P 37 cm.

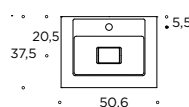

> Art. **A885** con foro rubinetto / with tap hole / avec trou pour robinet

> Art. **AA75** sz. foro rubinetto / without tap hole / sans trou pour robinet



### PAROS 71

Cristalplant

Lavabo consolle in cristalplant H 1,5. Compresso tappo copripiletta. Impiego per basi portalavabo L 70 x P 37 cm.

Console washbasin in cristalplant H 1.5. Includes plug cover. Use for washbasin units W. 70 x D. 37 cm.

Lavabo consolle en cristalplant H 1,5. Comprend cache-bonde. Utilisation pour éléments sous-lavabo L 70 x P 37 cm.

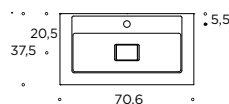

> Art. **A887** con foro rubinetto / with tap hole / avec trou pour robinet

> Art. **AA76** sz. foro rubinetto / without tap hole / sans trou pour robinet

**Cristalplant\*** è conosciuto per la superficie simile alla pietra naturale dall'effetto soft touch. È un materiale composto per la maggior parte da cariche minerali di triidrati di alluminio di elevata purezza, legati da resine di origine vegetale.

È un materiale omogeneo in tutto il suo spessore e può essere riparato da graffi, macchie ostinate e bruciature di sigaretta, riportando la superficie alla bellezza originale.

Per la pulizia è sufficiente acqua saponata o comuni detersivi, così da rimuovere la maggior parte delle macchie e dello sporco che si possono depositare sulla superficie. Per mantenere la caratteristica finitura opaca, utilizzare in fase di pulizia una spugna abrasiva e detersivi in gel o abrasivi, avendo cura di risciacquare subito la superficie.

**Cristalplant\*** is known for its natural stone-like surface with a soft touch effect. It is a composite material primarily made of high-purity aluminum trihydrate mineral fillers, bound by plant-based resins.

Is a homogeneous material throughout its thickness and can be repaired from scratches, stubborn stains, and cigarette burns, restoring the surface to its original beauty.

For cleaning, soapy water or common detergents are sufficient to remove most stains and dirt that may settle on the surface. To maintain the characteristic matte finish, use an abrasive sponge and gel or abrasive cleaners during the cleaning process, taking care to rinse the surface immediately.

**Cristalplant\*** est connu pour sa surface semblable à la pierre naturelle avec un effet soft touch. C'est un matériau composé en grande partie de charges minérales de trihydrates d'aluminium de haute pureté, liés par des résines d'origine végétale.

Est un matériau homogène dans toute son épaisseur et peut être réparé des rayures, des taches tenaces et des brûlures de cigarette, restaurant la surface à sa beauté originale.

Pour le nettoyage, il suffit d'eau savonneuse ou de détergents courants, afin d'éliminer la majorité des taches et de la saleté qui peuvent se déposer sur la surface. Pour maintenir la finition mate caractéristique, utiliser lors du nettoyage une éponge abrasive et des détergents en gel ou abrasifs, en veillant à rincer immédiatement la surface.



P/D  
37

# TODAY

Mineralguss



## TODAY 61

Mineralguss

Lavabo console in mineralguss H 8 cm.  
Impiego per basi portalavabo L 60 x P 37 cm.

Console washbasin in mineralguss H 8 cm.  
Use for washbasin units W 60 x D 37 cm.

Lavabo console en mineralguss H 8 cm.  
Utilisation pour éléments sous-lavabo L 60 x P 37 cm.

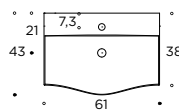

> Art. **A366**



## TODAY 71

Mineralguss

Lavabo console in mineralguss H 8 cm.  
Impiego per basi portalavabo L 70 x P 37 cm.

Console washbasin in mineralguss H 8 cm.  
Use for washbasin units W 70 x D 37 cm.

Lavabo console en mineralguss H 8 cm.  
Utilisation pour éléments sous-lavabo L 70 x P 37 cm.

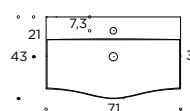

> Art. **A367**



## TODAY 86

Lavabo console in mineralguss H 8 cm.  
Impiego per basi portalavabo L 85 x P 37 cm.

Console washbasin in mineralguss H 8 cm.  
Use for washbasin units W 85 x D 37 cm.

Lavabo console en mineralguss H 8 cm.  
Utilisation pour éléments sous-lavabo L 85 x P 37 cm.

Mineralguss

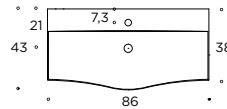

> Art. **A368**



## TODAY 96

Lavabo console in mineralguss H 8 cm.  
Impiego per basi portalavabo L 95 x P 37 cm.

Console washbasin in mineralguss H 8 cm.  
Use for washbasin units W 95 x D 37 cm.

Lavabo console en mineralguss H 8 cm.  
Utilisation pour éléments sous-lavabo L 95 x P 37 cm.

Mineralguss

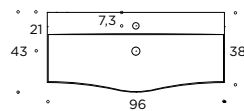

> Art. **A369**



## TODAY 106

Lavabo console in mineralguss H 8 cm.  
Impiego per basi portalavabo L 105 x P 37 cm.

Console washbasin in mineralguss H 8 cm.  
Use for washbasin units W 105 x D 37 cm.

Lavabo console en mineralguss H 8 cm.  
Utilisation pour éléments sous-lavabo L 105 x P 37 cm.

Mineralguss

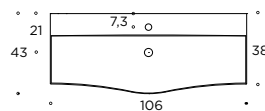

> Art. **A370**

P/D  
45

# THIN

Mineralguss



## THIN 61

Mineralguss

Lavabo consolle in mineralguss H 1,2 cm.  
Impiego per basi portalavabo L 60 x P 45 cm.

Console washbasin in mineralguss H 1.2 cm.  
Use for washbasin units W 60 x D 45 cm.

Lavabo consolle en mineralguss H 1,2 cm.  
Utilisation pour éléments sous-lavabo L 60 x P 45 cm.

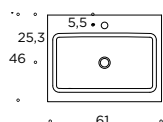

> Art. **A146**



## THIN 71

Mineralguss

Lavabo consolle in mineralguss H 1,2 cm.  
Impiego per basi portalavabo L 70 x P 45 cm.

Console washbasin in mineralguss H 1.2 cm.  
Use for washbasin units W 70 x D 45 cm.

Lavabo consolle en mineralguss H 1,2 cm.  
Utilisation pour éléments sous-lavabo L 70 x P 45 cm.

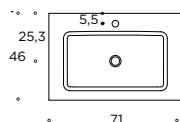

> Art. **A147**



## THIN 86

Mineralguss

Lavabo consolle in mineralguss H 1,2 cm.  
Impiego per basi portalavabo L 85 x P 45 cm.

Console washbasin in mineralguss H 1.2 cm.  
Use for washbasin units W 85 x D 45 cm.

Lavabo consolle en mineralguss H 1,2 cm.  
Utilisation pour éléments sous-lavabo L 85 x P 45 cm.

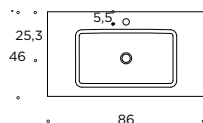

> Art. **A883**



## THIN 96

Mineralguss

Lavabo console in mineralguss H 1,2 cm.  
Impiego per basi portalavabo L 95 x P 45 cm.

Console washbasin in mineralguss H 1.2 cm.  
Use for washbasin units W 95 x D 45 cm.

Lavabo console en mineralguss H 1,2 cm.  
Utilisation pour éléments sous-lavabo L 95 x P 45 cm.

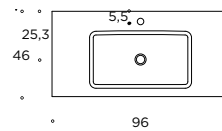

> Art. **A884**



## THIN 106

Mineralguss

Lavabo console in mineralguss H 1,2 cm.  
Impiego per basi portalavabo L 105 x P 45 cm.

Console washbasin in mineralguss H 1.2 cm.  
Use for washbasin units W 105 x D 45 cm.

Lavabo console en mineralguss H 1,2 cm.  
Utilisation pour éléments sous-lavabo L 105 x P 45 cm.

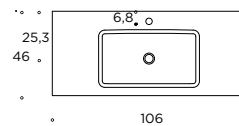

> Art. **A886**



## THIN 121

Mineralguss

Lavabo console in mineralguss H 1,2 cm.  
Impiego per basi portalavabo L 120 x P 45 cm.

Console washbasin in mineralguss H 1.2 cm.  
Use for washbasin units W 120 x D 45 cm.

Lavabo console en mineralguss H 1,2 cm.  
Utilisation pour éléments sous-lavabo L 120 x P 45 cm.

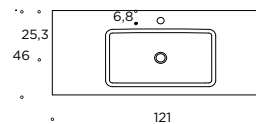

> Art. **A151**

P/D  
45

**OLLY**  
Mineralguss





## OLLY 61

Mineralguss - Tekno

Lavabo consolle in mineralguss / tekno H 4,5 cm.  
 Impiego per basi portalavabo L 60 x P 45 cm.

Console washbasin in mineralguss / tekno H 4,5 cm.  
 Use for washbasin units W 60 x D 45 cm.

Lavabo consolle en mineralguss / tekno H 4,5 cm.  
 Utilisation pour éléments sous-lavabo L 60 x P 45 cm.

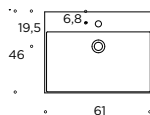

> Art. **A647** con foro rubinetto / with tap hole /  
 avec trou pour robinet

> Art. **AA51** sz. foro rubinetto / without tap hole /  
 sans trou pour robinet



## OLLY 71

Mineralguss - Tekno

Lavabo consolle in mineralguss / tekno H 4,5 cm.  
 Impiego per basi portalavabo L 70 x P 45 cm.

Console washbasin in mineralguss / tekno H 4,5 cm.  
 Use for washbasin units W 70 x D 45 cm.

Lavabo consolle en mineralguss / tekno H 4,5 cm.  
 Utilisation pour éléments sous-lavabo L 70 x P 45 cm.

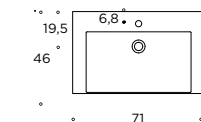

> Art. **A648** con foro rubinetto / with tap hole /  
 avec trou pour robinet

> Art. **AA52** sz. foro rubinetto / without tap hole /  
 sans trou pour robinet



## OLLY 86

Mineralguss - Tekno

Lavabo consolle in mineralguss / tekno H 4,5 cm.  
 Impiego per basi portalavabo L 85 x P 45 cm.

Console washbasin in mineralguss / tekno H 4,5 cm.  
 Use for washbasin units W 85 x D 45 cm.

Lavabo consolle en mineralguss / tekno H 4,5 cm.  
 Utilisation pour éléments sous-lavabo L 85 x P 45 cm.

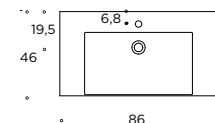

> Art. **A879** con foro rubinetto / with tap hole /  
 avec trou pour robinet

> Art. **AA59** sz. foro rubinetto / without tap hole /  
 sans trou pour robinet



## OLLY 96

Mineralguss - Tekno

Lavabo consolle in mineralguss / tekno H 4,5 cm.  
 Impiego per basi portalavabo L 95 x P 45 cm.

Console washbasin in mineralguss / tekno H 4,5 cm.  
 Use for washbasin units W 95 x D 45 cm.

Lavabo consolle en mineralguss / tekno H 4,5 cm.  
 Utilisation pour éléments sous-lavabo L 95 x P 45 cm.

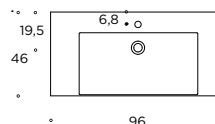

> Art. **A880** con foro rubinetto / with tap hole /  
 avec trou pour robinet

> Art. **AA60** sz. foro rubinetto / without tap hole /  
 sans trou pour robinet



## OLLY 106

Mineralguss - Tekno

Lavabo console in mineralguss / tekno H 4,5 cm.  
 Impiego per basi portalavabo L 105 x P 45 cm.

Console washbasin in mineralguss / tekno H 4,5 cm.  
 Use for washbasin units W 105 x D 45 cm.

Lavabo console en mineralguss / tekno H 4,5 cm.  
 Utilisation pour éléments sous-lavabo L 105 x P 45 cm.

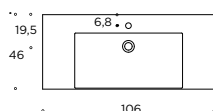

> Art. **A881** con foro rubinetto / with tap hole /  
 avec trou pour robinet

> Art. **AA61** sz. foro rubinetto / without tap hole /  
 sans trou pour robinet



## OLLY 121

Mineralguss - Tekno

Lavabo console in mineralguss / tekno H 4,5 cm.  
 Impiego per basi portalavabo L 120 x P 45 cm.

Console washbasin in mineralguss / tekno H 4,5 cm.  
 Use for washbasin units W 120 x D 45 cm.

Lavabo console en mineralguss / tekno H 4,5 cm.  
 Utilisation pour éléments sous-lavabo L 120 x P 45 cm.

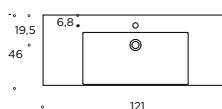

> Art. **A652** con foro rubinetto / with tap hole /  
 avec trou pour robinet

> Art. **AA56** sz. foro rubinetto / without tap hole /  
 sans trou pour robinet



## OLLY 121 DOPPIO

Mineralguss - Tekno

Lavabo console in mineralguss / tekno H 4,5 cm.  
 Impiego per basi portalavabo L 120 x P 45 cm.

Console washbasin in mineralguss / tekno H 4,5 cm.  
 Use for washbasin units W 120 x D 45 cm.

Lavabo console en mineralguss / tekno H 4,5 cm.  
 Utilisation pour éléments sous-lavabo L 120 x P 45 cm.

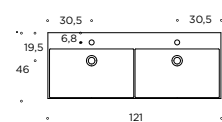

> Art. **A653** con foro rubinetto / with tap hole /  
 avec trou pour robinet

> Art. **AA57** sz. foro rubinetto / without tap hole /  
 sans trou pour robinet



## OLLY 141

Mineralguss - Tekno

Lavabo console in mineralguss / tekno H 4,5 cm.  
 Impiego per basi portalavabo L 140 x P 45 cm.

Console washbasin in mineralguss / tekno H 4,5 cm.  
 Use for washbasin units W 140 x D 45 cm.

Lavabo console en mineralguss / tekno H 4,5 cm.  
 Utilisation pour éléments sous-lavabo L 140 x P 45 cm.

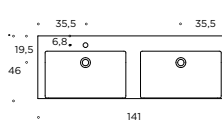

> Art. **A658** con foro rubinetto / with tap hole /  
 avec trou pour robinet

> Art. **AA58** sz. foro rubinetto / without tap hole /  
 sans trou pour robinet

P/D  
45

# FRIEND

Ceramica

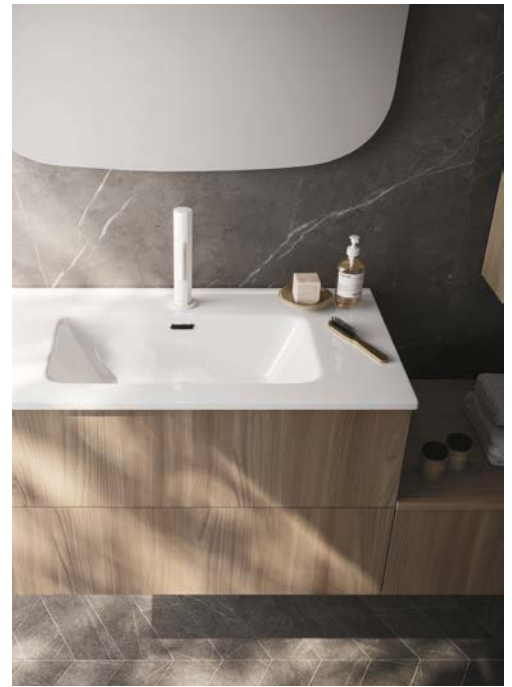

## FRIEND 61

Ceramica / Ceramic / Céramique

Lavabo consolle in ceramica H 1,5 cm.  
Impiego per basi portalavabo L 60 x P 45 cm.

Console washbasin in ceramic H 1,5 cm.  
Use for washbasin units W 60 x D 45 cm.

Lavabo consolle en céramique H 1,5 cm.  
Utilisation pour éléments sous-lavabo L 60 x P 45 cm.

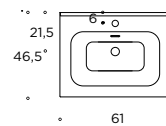

> Art. **A134**



## FRIEND 71

Ceramica / Ceramic / Céramique

Lavabo consolle in ceramica H 1,5 cm.  
Impiego per basi portalavabo L 70 x P 45 cm.

Console washbasin in ceramic H 1,5 cm.  
Use for washbasin units W 70 x D 45 cm.

Lavabo consolle en céramique H 1,5 cm.  
Utilisation pour éléments sous-lavabo L 70 x P 45 cm.

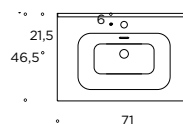

> Art. **A135**



## FRIEND 86

Ceramica / Ceramic / Céramique

**Lavabo consolle in ceramica H 1,5 cm.  
Impiego per basi portalavabo L 85 x P 50 cm.**

Console washbasin in ceramic H 1.5 cm.  
Use for washbasin units W 85 x D 50 cm.

Lavabo consolle en céramique H 1,5 cm.  
Utilisation pour éléments sous-lavabo L 85 x P 50 cm.

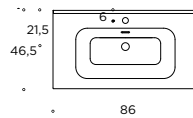

> Art. **A876**



## FRIEND 96

Ceramica / Ceramic / Céramique

**Lavabo consolle in ceramica H 1,5 cm.  
Impiego per basi portalavabo L 95 x P 50 cm.**

Console washbasin in ceramic H 1.5 cm.  
Use for washbasin units W 95 x D 50 cm.

Lavabo consolle en céramique H 1,5 cm.  
Utilisation pour éléments sous-lavabo L 95 x P 50 cm.

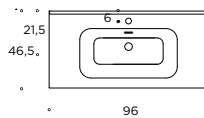

> Art. **A877**



## FRIEND 106

Ceramica / Ceramic / Céramique

**Lavabo consolle in ceramica H 1,5 cm.  
Impiego per basi portalavabo L 105 x P 50 cm.**

Console washbasin in ceramic H 1.5 cm.  
Use for washbasin units W 105 x D 50 cm.

Lavabo consolle en céramique H 1,5 cm.  
Utilisation pour éléments sous-lavabo L 105 x P 50 cm.

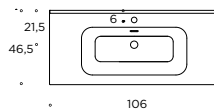

> Art. **A878**



## FRIEND 121 DOPPIO

Ceramica / Ceramic / Céramique

**Lavabo consolle in ceramica H 1,5 cm.  
Impiego per basi portalavabo L 120 x P 50 cm / L 70+50 x P 50 cm.**

Console washbasin in ceramic H 1.5 cm.  
Use for washbasin units W 120 x D 50 cm / W 70+50 x D 50 cm.

Lavabo consolle en céramique H 1,5 cm.  
Utilisation pour éléments sous-lavabo L 120 x P 50 cm / L 70+50 x P 50 cm.

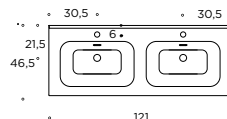

> Art. **A139**

P/D  
50

# SUGAR

Mineralguss

NEW





## SUGAR 61

Mineralguss

Lavabo consolle in mineralguss H 1,2 cm.  
 Impiego per basi portalavabo L 60 x P 50 cm.

Console washbasin in mineralguss H 1.2 cm.  
 Use for washbasin units W 60 x D 50 cm.

Lavabo consolle en mineralguss H 1,2 cm.  
 Utilisation pour éléments sous-lavabo L 60 x P 50 cm.

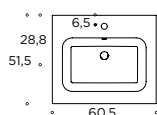

> Art. **R06H** con foro rubinetto / with tap hole /  
 avec trou pour robinet

> Art. **R07F** sz. foro rubinetto / without tap hole /  
 sans trou pour robinet



## SUGAR 71

Mineralguss

Lavabo consolle in mineralguss H 1,2 cm.  
 Impiego per basi portalavabo L 70 x P 50 cm.

Console washbasin in mineralguss H 1.2 cm.  
 Use for washbasin units W 70 x D 50 cm.

Lavabo consolle en mineralguss H 1,2 cm.  
 Utilisation pour éléments sous-lavabo L 70 x P 50 cm.

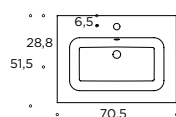

> Art. **R06J** con foro rubinetto / with tap hole /  
 avec trou pour robinet

> Art. **R07G** sz. foro rubinetto / without tap hole /  
 sans trou pour robinet



## SUGAR 86

Mineralguss

Lavabo consolle in mineralguss H 1,2 cm.  
 Impiego per basi portalavabo L 85 x P 50 cm.

Console washbasin in mineralguss H 1.2 cm.  
 Use for washbasin units W 85 x D 50 cm.

Lavabo consolle en mineralguss H 1,2 cm.  
 Utilisation pour éléments sous-lavabo L 85 x P 50 cm.

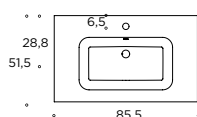

> Art. **R06L** con foro rubinetto / with tap hole /  
 avec trou pour robinet

> Art. **R07H** sz. foro rubinetto / without tap hole /  
 sans trou pour robinet



## SUGAR 96

Mineralguss

Lavabo consolle in mineralguss H 1,2 cm.  
 Impiego per basi portalavabo L 95 x P 50 cm.

Console washbasin in mineralguss H 1.2 cm.  
 Use for washbasin units W 95 x D 50 cm.

Lavabo consolle en mineralguss H 1,2 cm.  
 Utilisation pour éléments sous-lavabo L 95 x P 50 cm.

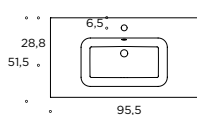

> Art. **R06N** con foro rubinetto / with tap hole /  
 avec trou pour robinet

> Art. **R07I** sz. foro rubinetto / without tap hole /  
 sans trou pour robinet



## SUGAR 106

Mineralguss

Lavabo consolle in mineralguss H 1,2 cm.  
Impiego per basi portalavabo L 105 x P 50 cm.

Console washbasin in mineralguss H 1.2 cm.  
Use for washbasin units W 105 x D 50 cm.

Lavabo consolle en mineralguss H 1,2 cm.  
Utilisation pour éléments sous-lavabo L 105 x P 50 cm.

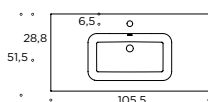

> Art. **R06P** con foro rubinetto / with tap hole /  
avec trou pour robinet

> Art. **R07J** sz. foro rubinetto / without tap hole /  
sans trou pour robinet



## SUGAR 106 DX-SX

Mineralguss

Lavabo consolle in mineralguss H 1,2 cm.  
Impiego per basi portalavabo L 105 x P 50 cm / L 70+35 x P 50 cm.

Console washbasin in mineralguss H 1.2 cm.  
Use for washbasin units W 105 x D 50 cm / W 70+35 x D 50 cm.

Lavabo consolle en mineralguss H 1,2 cm.  
Utilisation pour éléments sous-lavabo L 105 x P 50 cm / L 70+35 x P 50 cm.

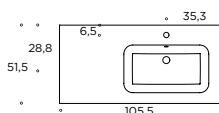

> Art. **R06R** (DX) con foro rub. / with tap hole /  
> Art. **R06T** (SX) avec trou pour robinet

> Art. **R07K** (DX) sz. foro rub. / without tap hole /  
> Art. **R07L** (SX) sans trou pour robinet



## SUGAR 121

Mineralguss

Lavabo consolle in mineralguss H 1,2 cm.  
Impiego per basi portalavabo L 120 x P 50 cm.

Console washbasin in mineralguss H 1.2 cm.  
Use for washbasin units W 120 x D 50 cm.

Lavabo consolle en mineralguss H 1,2 cm.  
Utilisation pour éléments sous-lavabo L 120 x P 50 cm.

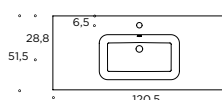

> Art. **R06V** con foro rubinetto / with tap hole /  
avec trou pour robinet

> Art. **R07M** sz. foro rubinetto / without tap hole /  
sans trou pour robinet



## SUGAR 121 DX-SX

Mineralguss

Lavabo consolle in mineralguss H 1,2 cm.  
Impiego per basi portalavabo L 120 x P 50 cm / L 70+50 x P 50 cm.

Console washbasin in mineralguss H 1.2 cm.  
Use for washbasin units W 120 x D 50 cm / W 70+50 x D 50 cm.

Lavabo consolle en mineralguss H 1,2 cm.  
Utilisation pour éléments sous-lavabo L 120 x P 50 cm / L 70+50 x P 50 cm.

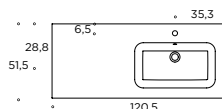

> Art. **R06X** (DX) con foro rub. / with tap hole /  
> Art. **R06Z** (SX) avec trou pour robinet

> Art. **R07N** (DX) sz. foro rub. / without tap hole /  
> Art. **R07O** (SX) sans trou pour robinet

P/D  
50

# BENT

Tekno Geacril

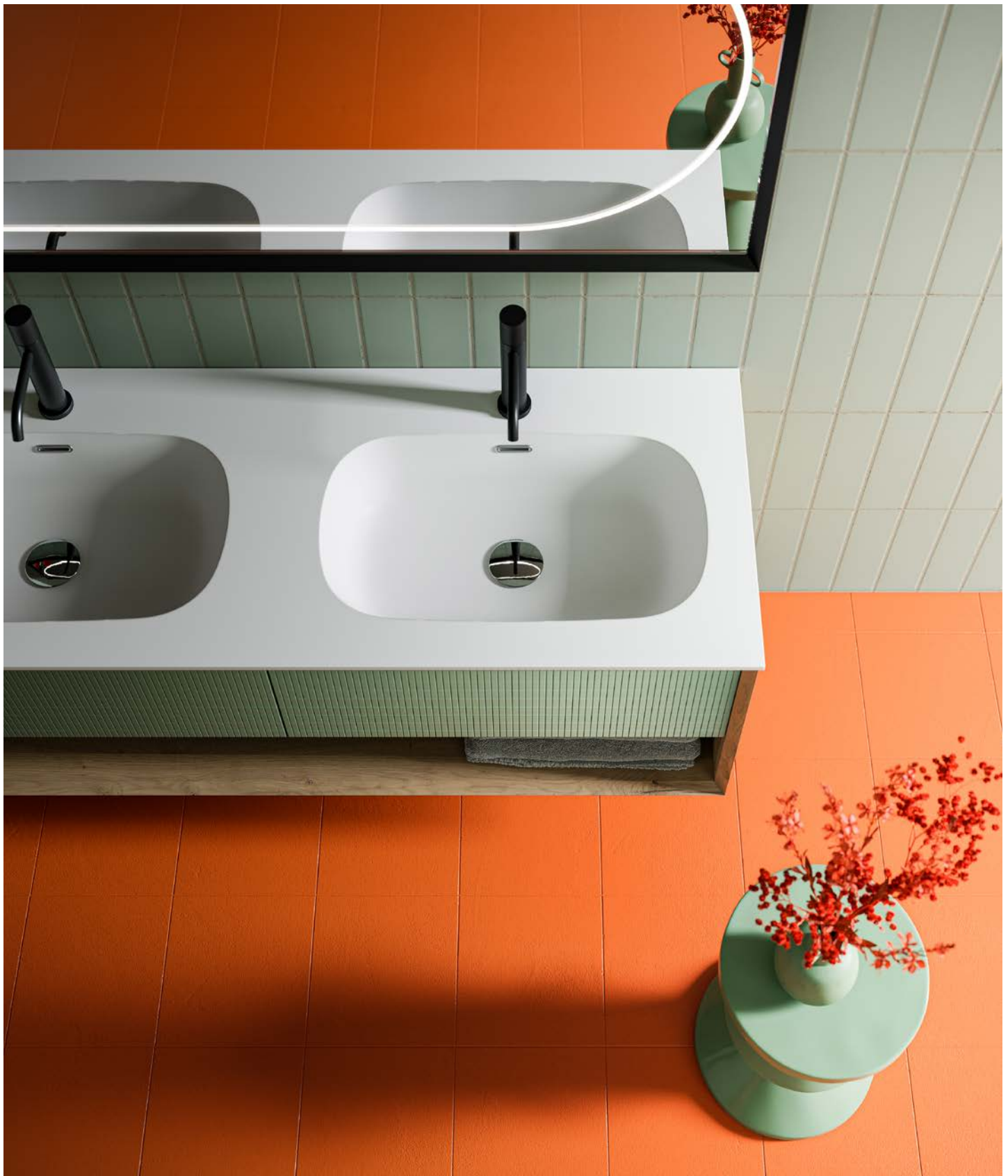



## BENT 61

Tekno geacril

Lavabo consolle in tekno geacril H 1,2 cm.  
Impiego per basi portalavabo L 60 x P 50 cm.

Console washbasin in tekno geacril H 1.2 cm.  
Use for washbasin units W 60 x D 50 cm.

Lavabo consolle en tekno geacril H 1,2 cm.  
Utilisation pour éléments sous-lavabo L 60 x P 50 cm.

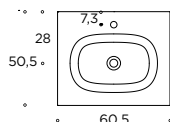

> Art. **A890** con foro rubinetto / with tap hole /  
avec trou pour robinet

> Art. **AA62** sz. foro rubinetto / without tap hole /  
sans trou pour robinet



## BENT 71

Tekno geacril

Lavabo consolle in tekno geacril H 1,2 cm.  
Impiego per basi portalavabo L 70 x P 50 cm.

Console washbasin in tekno geacril H 1.2 cm.  
Use for washbasin units W 70 x D 50 cm.

Lavabo consolle en tekno geacril H 1,2 cm.  
Utilisation pour éléments sous-lavabo L 70 x P 50 cm.

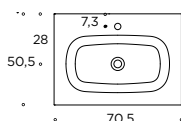

> Art. **A891** con foro rubinetto / with tap hole /  
avec trou pour robinet

> Art. **AA63** sz. foro rubinetto / without tap hole /  
sans trou pour robinet



## BENT 86

Tekno geacril

Lavabo consolle in tekno geacril H 1,2 cm.  
Impiego per basi portalavabo L 85 x P 50 cm.

Console washbasin in tekno geacril H 1.2 cm.  
Use for washbasin units W 85 x D 50 cm.

Lavabo consolle en tekno geacril H 1,2 cm.  
Utilisation pour éléments sous-lavabo L 85 x P 50 cm.

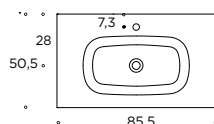

> Art. **A892** con foro rubinetto / with tap hole /  
avec trou pour robinet

> Art. **AA64** sz. foro rubinetto / without tap hole /  
sans trou pour robinet



## BENT 96

Tekno geacril

Lavabo consolle in tekno geacril H 1,2 cm.  
Impiego per basi portalavabo L 95 x P 50 cm.

Console washbasin in tekno geacril H 1.2 cm.  
Use for washbasin units W 95 x D 50 cm.

Lavabo consolle en tekno geacril H 1,2 cm.  
Utilisation pour éléments sous-lavabo L 95 x P 50 cm.

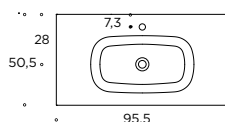

> Art. **A893** con foro rubinetto / with tap hole /  
avec trou pour robinet

> Art. **AA65** sz. foro rubinetto / without tap hole /  
sans trou pour robinet



## BENT 106

Tekno geacril

Lavabo consolle in tekno geacril H 1,2 cm.  
 Impiego per basi portalavabo L 105 x P 50 cm.

Console washbasin in tekno geacril H 1.2 cm.  
 Use for washbasin units W 105 x D 50 cm.

Lavabo consolle en tekno geacril H 1,2 cm.  
 Utilisation pour éléments sous-lavabo L 105 x P 50 cm.

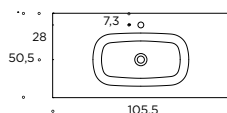

> Art. **A894** con foro rubinetto / with tap hole /  
 avec trou pour robinet

> Art. **AA66** sz. foro rubinetto / without tap hole /  
 sans trou pour robinet



## BENT 106 DX-SX

Tekno geacril

Lavabo consolle in tekno geacril H 1,2 cm.  
 Impiego per basi portalavabo L 105 x P 50 cm / L 70+35 x P 50 cm.

Console washbasin in tekno geacril H 1.2 cm.  
 Use for washbasin units W 105 x D 50 cm / W 70+35 x D 50 cm.

Lavabo consolle en tekno geacril H 1,2 cm.  
 Utilisation pour éléments sous-lavabo L 105 x P 50 cm / L 70+35 x P 50 cm.

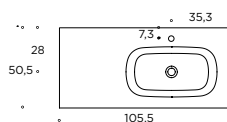

con foro rubinetto / with tap hole / avec trou pour robinet

> Art. **R077** DX / RHS / DROITE  
 > Art. **R078** SX / LHS / GAUCHE

sz. foro rubinetto / without tap hole / sans trou pour robinet

> Art. **R075** DX / RHS / DROITE  
 > Art. **R076** SX / LHS / GAUCHE



## BENT 121

Tekno geacril

Lavabo consolle in tekno geacril H 1,2 cm.  
 Impiego per basi portalavabo L 120 x P 50 cm.

Console washbasin in tekno geacril H 1.2 cm.  
 Use for washbasin units W 120 x D 50 cm.

Lavabo consolle en tekno geacril H 1,2 cm.  
 Utilisation pour éléments sous-lavabo L 120 x P 50 cm.

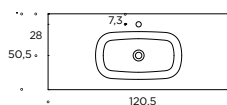

> Art. **A895** con foro rubinetto / with tap hole /  
 avec trou pour robinet

> Art. **AA67** sz. foro rubinetto / without tap hole /  
 sans trou pour robinet



## BENT 121 DX-SX

Tekno geacril

Lavabo consolle in tekno geacril H 1,2 cm.  
 Impiego per basi portalavabo L 120 x P 50 cm / L 70+50 x P 50 cm.

Console washbasin in tekno geacril H 1.2 cm.  
 Use for washbasin units W 120 x D 50 cm / W 70+50 x D 50 cm.

Lavabo consolle en tekno geacril H 1,2 cm.  
 Utilisation pour éléments sous-lavabo L 120 x P 50 cm / L 70+50 x P 50 cm.

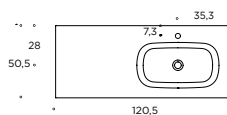

con foro rubinetto / with tap hole / avec trou pour robinet

> Art. **R07B** DX / RHS / DROITE  
 > Art. **R07C** SX / LHS / GAUCHE

sz. foro rubinetto / without tap hole / sans trou pour robinet

> Art. **R079** DX / RHS / DROITE  
 > Art. **R07A** SX / LHS / GAUCHE



## BENT 121 DOPPIO

Tekno geacril

Lavabo consolle in tekno geacril H 1,2 cm.  
 Impiego per basi portalavabo L 120 x P 50 cm / L 60+60 x P 50 cm.

Console washbasin in tekno geacril H 1.2 cm.  
 Use for washbasin units W 120 x D 50 cm / W 60+60 x D 50 cm.

Lavabo consolle en tekno geacril H 1,2 cm.  
 Utilisation pour éléments sous-lavabo L 120 x P 50 cm / L 60+60 x P 50 cm.

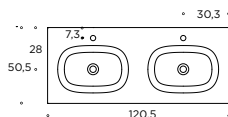

> Art. **A896** con foro rubinetto / with tap hole /  
 avec trou pour robinet

> Art. **AA71** sz. foro rubinetto / without tap hole /  
 sans trou pour robinet



## BENT 141

Tekno geacril

Lavabo consolle in tekno geacril H 1,2 cm.  
 Impiego per basi portalavabo L 140 x P 50 cm / L 35+70+35 x P 50 cm.

Console washbasin in tekno geacril H 1.2 cm.  
 Use for washbasin units W 140 x D 50 cm / W 35+70+35 x D 50 cm.

Lavabo consolle en tekno geacril H 1,2 cm.  
 Utilisation pour éléments sous-lavabo L 140 x P 50 cm / L 35+70+35 x P 50 cm.

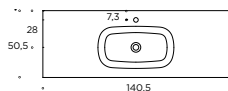

> Art. **A897** con foro rubinetto / with tap hole /  
 avec trou pour robinet

> Art. **AA68** sz. foro rubinetto / without tap hole /  
 sans trou pour robinet



## BENT 141 DX-SX

Tekno geacril

Lavabo consolle in tekno geacril H 1,2 cm.  
 Impiego per basi portalavabo L 140 x P 50 cm / L 70+70 x P 50 cm.

Console washbasin in tekno geacril H 1.2 cm.  
 Use for washbasin units W 140 x D 50 cm / W 70+70 x D 50 cm.

Lavabo consolle en tekno geacril H 1,2 cm.  
 Utilisation pour éléments sous-lavabo L 140 x P 50 cm / L 70+70 x P 50 cm.

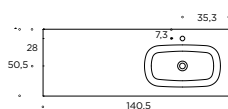

con foro rubinetto / with tap hole / avec trou pour robinet

> Art. **A899** DX / RHS / DROITE

> Art. **A898** SX / LHS / GAUCHE

sz. foro rubinetto / without tap hole / sans trou pour robinet

> Art. **AA70** DX / RHS / DROITE

> Art. **AA69** SX / LHS / GAUCHE



## BENT 141 DOPPIO

Tekno geacril

Lavabo consolle in tekno geacril H 1,2 cm.  
 Impiego per basi portalavabo L 140 x P 50 cm / L 70+70 x P 50 cm.

Console washbasin in tekno geacril H 1.2 cm.  
 Use for washbasin units W 140 x D 50 cm / W 70+70 x D 50 cm.

Lavabo consolle en tekno geacril H 1,2 cm.  
 Utilisation pour éléments sous-lavabo L 140 x P 50 cm / L 70+70 x P 50 cm.

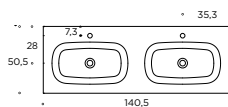

> Art. **A900** con foro rubinetto / with tap hole /  
 avec trou pour robinet

> Art. **AA72** sz. foro rubinetto / without tap hole /  
 sans trou pour robinet

P/D  
50

# JUNO

Tekno





## JUNO 51

Tekno

Lavabo consolle in tekno H 1,2 cm.  
 Impiego per basi portalavabo L 50 x P 50 cm.

Console washbasin in tekno H 1.2 cm.  
 Use for washbasin units W 50 x D 50 cm.

Lavabo consolle en tekno H 1,2 cm.  
 Utilisation pour éléments sous-lavabo L 50 x P 50 cm.

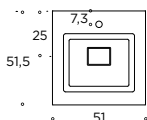

> Art. **A970** con foro rubinetto / with tap hole /  
 avec trou pour robinet

> Art. **AA90** sz. foro rubinetto / without tap hole /  
 sans trou pour robinet



## JUNO 61

Tekno

Lavabo consolle in tekno H 1,2 cm.  
 Impiego per basi portalavabo L 60 x P 50 cm.

Console washbasin in tekno H 1.2 cm.  
 Use for washbasin units W 60 x D 50 cm.

Lavabo consolle en tekno H 1,2 cm.  
 Utilisation pour éléments sous-lavabo L 60 x P 50 cm.

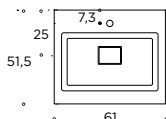

> Art. **A991** con foro rubinetto / with tap hole /  
 avec trou pour robinet

> Art. **AA91** sz. foro rubinetto / without tap hole /  
 sans trou pour robinet



## JUNO 71

Tekno

Lavabo consolle in tekno H 1,2 cm.  
 Impiego per basi portalavabo L 70 x P 50 cm.

Console washbasin in tekno H 1.2 cm.  
 Use for washbasin units W 70 x D 50 cm.

Lavabo consolle en tekno H 1,2 cm.  
 Utilisation pour éléments sous-lavabo L 70 x P 50 cm.

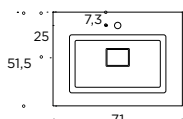

> Art. **A992** con foro rubinetto / with tap hole /  
 avec trou pour robinet

> Art. **AA92** sz. foro rubinetto / without tap hole /  
 sans trou pour robinet



## JUNO 86

Tekno

Lavabo consolle in tekno H 1,2 cm.  
 Impiego per basi portalavabo L 85 x P 50 cm.

Console washbasin in tekno H 1.2 cm.  
 Use for washbasin units W 85 x D 50 cm.

Lavabo consolle en tekno H 1,2 cm.  
 Utilisation pour éléments sous-lavabo L 85 x P 50 cm.

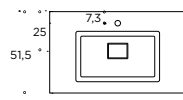

> Art. **A993** con foro rubinetto / with tap hole /  
 avec trou pour robinet

> Art. **AA93** sz. foro rubinetto / without tap hole /  
 sans trou pour robinet



## JUNO 96

Tekno

Lavabo consolle in tekno H 1,2 cm.  
 Impiego per basi portalavabo L 95 x P 50 cm.

Console washbasin in tekno H 1.2 cm.  
 Use for washbasin units W 95 x D 50 cm.

Lavabo consolle en tekno H 1,2 cm.  
 Utilisation pour éléments sous-lavabo L 95 x P 50 cm.

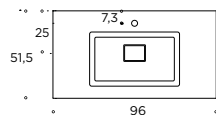

> Art. **A994** con foro rubinetto / with tap hole /  
 avec trou pour robinet

> Art. **AA94** sz. foro rubinetto / without tap hole /  
 sans trou pour robinet



## JUNO 106

Tekno

Lavabo consolle in tekno H 1,2 cm.  
 Impiego per basi portalavabo L 105 x P 50 cm.

Console washbasin in tekno H 1.2 cm.  
 Use for washbasin units W 105 x D 50 cm.

Lavabo consolle en tekno H 1,2 cm.  
 Utilisation pour éléments sous-lavabo L 105 x P 50 cm.

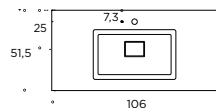

> Art. **A995** con foro rubinetto / with tap hole /  
 avec trou pour robinet

> Art. **AA95** sz. foro rubinetto / without tap hole /  
 sans trou pour robinet



## JUNO 106 DX-SX

Tekno

Lavabo consolle in tekno H 1,2 cm.  
 Impiego per basi portalavabo L 105 x P 50 cm / L 70+35 x P 50 cm.

Console washbasin in tekno H 1.2 cm.  
 Use for washbasin units W 105 x D 50 cm / W 70+35 x D 50 cm.

Lavabo consolle en tekno H 1,2 cm.  
 Utilisation pour éléments sous-lavabo L 105 x P 50 cm / L 70+35 x P 50 cm.

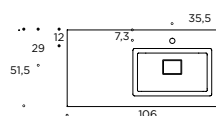

con foro rubinetto / with tap hole / avec trou pour robinet

> Art. **R073** DX / RHS / DROITE

> Art. **R074** SX / LHS / GAUCHE

sz. foro rubinetto / without tap hole / sans trou pour robinet

> Art. **R07E** DX / RHS / DROITE

> Art. **R07D** SX / LHS / GAUCHE



## JUNO 121

Tekno

Lavabo consolle in tekno H 1,2 cm.  
 Impiego per basi portalavabo L 120 x P 50 cm.

Console washbasin in tekno H 1.2 cm.  
 Use for washbasin units W 120 x D 50 cm.

Lavabo consolle en tekno H 1,2 cm.  
 Utilisation pour éléments sous-lavabo L 120 x P 50 cm.

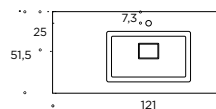

> Art. **A996** con foro rubinetto / with tap hole /  
 avec trou pour robinet

> Art. **AA96** sz. foro rubinetto / without tap hole /  
 sans trou pour robinet



## JUNO 121 DX-SX

Tekno

Lavabo consolle in tekno H 1,2 cm.  
 Impiego per basi portalavabo L 120 x P 50 cm / L 70+50 x P 50 cm.

Console washbasin in tekno H 1.2 cm.  
 Use for washbasin units W 120 x D 50 cm / W 70+50 x D 50 cm.

Lavabo consolle en tekno H 1,2 cm.  
 Utilisation pour éléments sous-lavabo L 120 x P 50 cm / L 70+50 x P 50 cm.

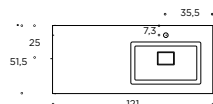

con foro rubinetto / with tap hole / avec trou pour robinet

- > Art. **A998** DX / RHS / DROITE
- > Art. **A997** SX / LHS / GAUCHE

sz. foro rubinetto / without tap hole / sans trou pour robinet

- > Art. **AA98** DX / RHS / DROITE
- > Art. **AA97** SX / LHS / GAUCHE



## JUNO 121 DOPPIO

Tekno

Lavabo consolle in tekno H 1,2 cm.  
 Impiego per basi portalavabo L 120 x P 50 cm / L 60+60 x P 50 cm.

Console washbasin in tekno H 1.2 cm.  
 Use for washbasin units W 120 x D 50 cm / W 60+60 x D 50 cm.

Lavabo consolle en tekno H 1,2 cm.  
 Utilisation pour éléments sous-lavabo L 120 x P 50 cm / L 60+60 x P 50 cm.

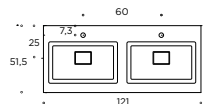

- > Art. **A999** con foro rubinetto / with tap hole / avec trou pour robinet

- > Art. **AA99** sz. foro rubinetto / without tap hole / sans trou pour robinet



## JUNO 141 DX-SX

Tekno

Lavabo consolle in tekno H 1,2 cm.  
 Impiego per basi portalavabo L 140 x P 50 cm / L 70+70 x P 50 cm.

Console washbasin in tekno H 1.2 cm.  
 Use for washbasin units W 140 x D 50 cm / W 70+70 x D 50 cm.

Lavabo consolle en tekno H 1,2 cm.  
 Utilisation pour éléments sous-lavabo L 140 x P 50 cm / L 70+70 x P 50 cm.

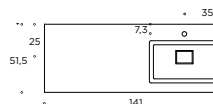

con foro rubinetto / with tap hole / avec trou pour robinet

- > Art. **AA18** DX / RHS / DROITE
- > Art. **AA19** SX / LHS / GAUCHE

sz. foro rubinetto / without tap hole / sans trou pour robinet

- > Art. **AA87** DX / RHS / DROITE
- > Art. **AA88** SX / LHS / GAUCHE



## JUNO 141 DOPPIO

Tekno

Lavabo consolle in tekno H 1,2 cm.  
 Impiego per basi portalavabo L 140 x P 50 cm / L 70+70 x P 50 cm.

Console washbasin in tekno H 1.2 cm.  
 Use for washbasin units W 140 x D 50 cm / W 70+70 x D 50 cm.

Lavabo consolle en tekno H 1,2 cm.  
 Utilisation pour éléments sous-lavabo L 140 x P 50 cm / L 70+70 x P 50 cm.

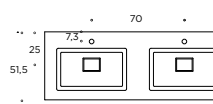

- > Art. **AA20** con foro rubinetto / with tap hole / avec trou pour robinet

- > Art. **AA89** sz. foro rubinetto / without tap hole / sans trou pour robinet

P/D  
50

# QUBO

Ceramica





## QUBO 71

Ceramica / Ceramic / Céramique

Lavabo consolle in ceramica H 1,5 cm.  
 Impiego per basi portalavabo L 70 x P 50 cm.

Console washbasin in ceramic H 1,5 cm.  
 Use for washbasin units W 70 x D 50 cm.

Lavabo consolle en céramique H 1,5 cm.  
 Utilisation pour éléments sous-lavabo L 70 x P 50 cm.

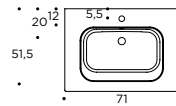

> Art. **A736** con foro rubinetto / with tap hole /  
 avec trou pour robinet

> Art. **AA46** sz. foro rubinetto / without tap hole /  
 sans trou pour robinet



## QUBO 86

Ceramica / Ceramic / Céramique

Lavabo consolle in ceramica H 1,5 cm.  
 Impiego per basi portalavabo L 85 x P 50 cm.

Console washbasin in ceramic H 1,5 cm.  
 Use for washbasin units W 85 x D 50 cm.

Lavabo consolle en céramique H 1,5 cm.  
 Utilisation pour éléments sous-lavabo L 85 x P 50 cm.

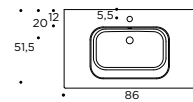

> Art. **A737** con foro rubinetto / with tap hole /  
 avec trou pour robinet

> Art. **AA47** sz. foro rubinetto / without tap hole /  
 sans trou pour robinet



## QUBO 96

Ceramica / Ceramic / Céramique

Lavabo consolle in ceramica H 1,5 cm.  
 Impiego per basi portalavabo L 95 x P 50 cm.

Console washbasin in ceramic H 1,5 cm.  
 Use for washbasin units W 95 x D 50 cm.

Lavabo consolle en céramique H 1,5 cm.  
 Utilisation pour éléments sous-lavabo L 95 x P 50 cm.

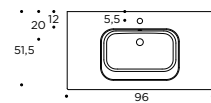

> Art. **A738** con foro rubinetto / with tap hole /  
 avec trou pour robinet

> Art. **AA48** sz. foro rubinetto / without tap hole /  
 sans trou pour robinet



## QUBO 106

Ceramica / Ceramic / Céramique

Lavabo consolle in ceramica H 1,5 cm.  
 Impiego per basi portalavabo L 105 x P 50 cm.

Console washbasin in ceramic H 1,5 cm.  
 Use for washbasin units W 105 x D 50 cm.

Lavabo consolle en céramique H 1,5 cm.  
 Utilisation pour éléments sous-lavabo L 105 x P 50 cm.

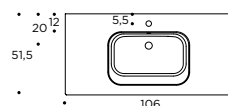

> Art. **A739** con foro rubinetto / with tap hole /  
 avec trou pour robinet

> Art. **AA49** sz. foro rubinetto / without tap hole /  
 sans trou pour robinet



## QUBO 106 DX-SX

Ceramica / Ceramic / Céramique

Lavabo consolle in ceramica H 1,5 cm.  
 Impiego per basi portalavabo L 105 x P 50 cm.

Console washbasin in ceramic H 1.5 cm.  
 Use for washbasin units W 105 x D 50 cm.

Lavabo consolle en céramique H 1,5 cm.  
 Utilisation pour éléments sous-lavabo L 105 x P 50 cm.

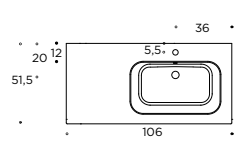

con foro rubinetto / with tap hole / avec trou pour robinet

> Art. **A371** DX / RHS / DROITE  
 > Art. **A372** SX / LHS / GAUCHE

sz. foro rubinetto / without tap hole / sans trou pour robinet

> Art. **AA41** DX / RHS / DROITE  
 > Art. **AA42** SX / LHS / GAUCHE



## QUBO 121

Ceramica / Ceramic / Céramique

Lavabo consolle in ceramica H 1,5 cm.  
 Impiego per basi portalavabo L 120 x P 50 cm.

Console washbasin in ceramic H 1.5 cm.  
 Use for washbasin units W 120 x D 50 cm.

Lavabo consolle en céramique H 1,5 cm.  
 Utilisation pour éléments sous-lavabo L 120 x P 50 cm.

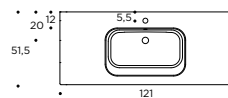

> Art. **A036** con foro rubinetto / with tap hole / avec trou pour robinet

> Art. **AA40** sz. foro rubinetto / without tap hole / sans trou pour robinet



## QUBO 121 DX-SX

Ceramica / Ceramic / Céramique

Lavabo consolle in ceramica H 1,5 cm.  
 Impiego per basi portalavabo L 120 x P 50 cm.

Console washbasin in ceramic H 1.5 cm.  
 Use for washbasin units W 120 x D 50 cm.

Lavabo consolle en céramique H 1,5 cm.  
 Utilisation pour éléments sous-lavabo L 120 x P 50 cm.

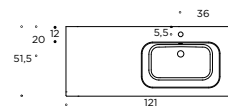

con foro rubinetto / with tap hole / avec trou pour robinet

> Art. **A373** DX / RHS / DROITE  
 > Art. **A374** SX / LHS / GAUCHE

sz. foro rubinetto / without tap hole / sans trou pour robinet

> Art. **AA43** DX / RHS / DROITE  
 > Art. **AA44** SX / LHS / GAUCHE



## QUBO 121 DOPPIO

Ceramica / Ceramic / Céramique

Lavabo consolle in ceramica H 1,5 cm.  
 Impiego per basi portalavabo L 120 x P 50 cm.

Console washbasin in ceramic H 1.5 cm.  
 Use for washbasin units W 120 x D 50 cm.

Lavabo consolle en céramique H 1,5 cm.  
 Utilisation pour éléments sous-lavabo L 120 x P 50 cm.

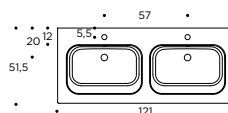

> Art. **A735** con foro rubinetto / with tap hole / avec trou pour robinet

> Art. **AA50** sz. foro rubinetto / without tap hole / sans trou pour robinet

P/D  
50

# MELODY

Ceramica





## MELODY 72

Ceramica / Ceramic / Céramique

**Lavabo consolle in ceramica H 1,5 cm.  
Impiego per basi portalavabo L 70 x P 50 cm.**

Console washbasin in ceramic H 1,5 cm.  
Use for washbasin units W 70 x D 50 cm.

Lavabo consolle en céramique H 1,5 cm.  
Utilisation pour éléments sous-lavabo L 70 x P 50 cm.

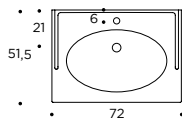

> Art. **A217**



## MELODY 107

Ceramica / Ceramic / Céramique

**Lavabo consolle in ceramica H 1,5 cm.  
Impiego per basi portalavabo L 105 x P 50 cm.**

Console washbasin in ceramic H 1,5 cm.  
Use for washbasin units W 105 x D 50 cm.

Lavabo consolle en céramique H 1,5 cm.  
Utilisation pour éléments sous-lavabo L 105 x P 50 cm.

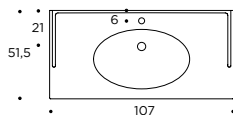

> Art. **A218**



## MELODY 122

Ceramica / Ceramic / Céramique

**Lavabo consolle in ceramica H 1,5 cm.  
Impiego per basi portalavabo L 120 x P 50 cm.**

Console washbasin in ceramic H 1,5 cm.  
Use for washbasin units W 120 x D 50 cm.

Lavabo consolle en céramique H 1,5 cm.  
Utilisation pour éléments sous-lavabo L 120 x P 50 cm.

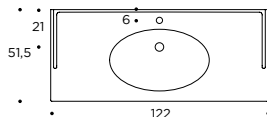

> Art. **A219**



MOBY 85  
Tekno Bianco

P/D  
50

## MOBY 70

Tekno



Piano top con lavabo integrato sp. 1,2 cm.  
Per basi portalavabo semincasso min. L 70 x P 50 cm

Top with built-in washbasin 1.2 cm thick  
Use for semi-recessed washbasin units min. W 70 x D 50 cm

Plan de toilette avec lavabo intégré ép. 1,2 cm.  
Pour éléments sous-lavabo semi-encastrés min. L 70 x P 50 cm

**Solo per basi portalavabo FUSION MOBY.**  
Only for FUSION MOBY washbasin units.  
Uniquement pour les bases de lavabo FUSION MOBY.

Art.	mobile / base unit / élément bas
<b>F700</b>	70 cm

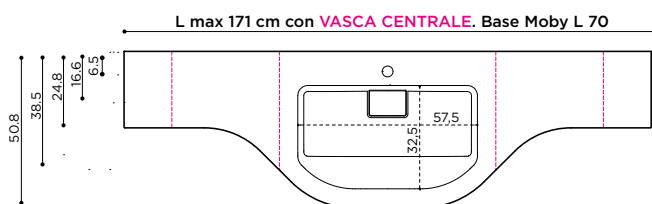

tekno  
Bianco

P/D  
50

## MOBY 85

Tekno



Piano top con lavabo integrato sp. 1,2 cm.  
Per basi portalavabo semincasso min. L 85 x P 50 cm

Top with built-in washbasin 1.2 cm thick  
Use for semi-recessed washbasin units min. W 85 x D 50 cm

Plan de toilette avec lavabo intégré ép. 1,2 cm.  
Pour éléments sous-lavabo semi-encastrés min. L 85 x P 50 cm

**Solo per basi portalavabo FUSION MOBY.**  
Only for FUSION MOBY washbasin units.  
Uniquement pour les bases de lavabo FUSION MOBY.

Art.	mobile / base unit / élément bas
<b>F800</b>	85 cm

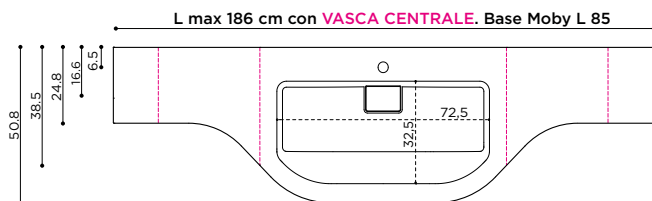

tekno  
Bianco

P/D  
50

# SKINNY

Tekno

NEW

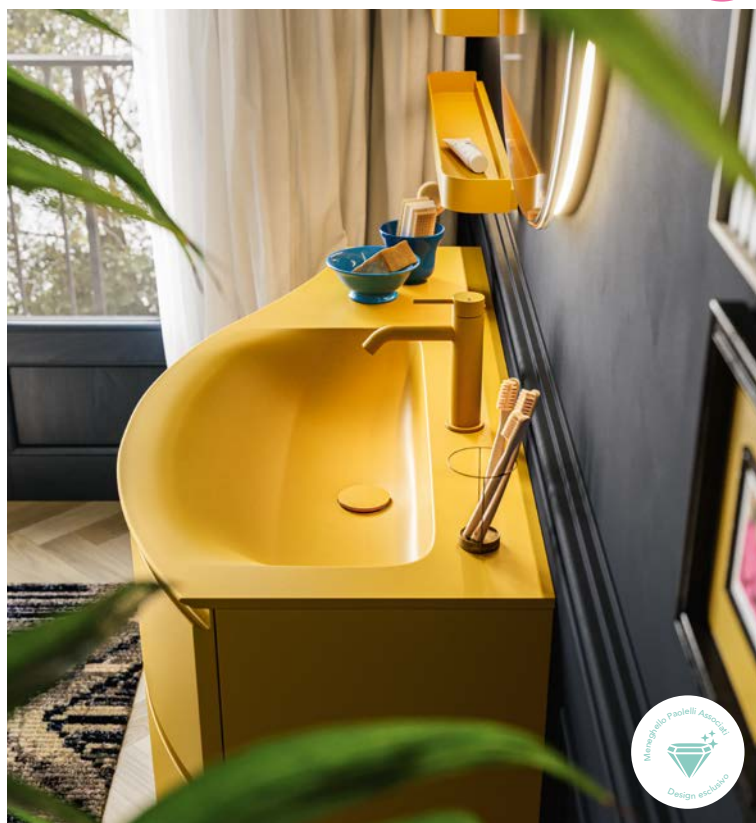

Piano top con lavabo integrato sp. 1,3 cm.  
Per basi portalavabo Fusion L 85 + terminale Slim L 35 cm

Top with built-in washbasin 1.3 cm thick  
For washbasin units Fusion W. 85 cm + Slim terminal W. 35 cm

Plan de toilette avec lavabo intégré ép. 1,3 cm.  
Pour éléments sous-lavabo Fusion L 85 cm + terminal Slim L 35 cm

**Solo per basi portalavabo FUSION.**  
Only for FUSION washbasin units.  
Uniquement pour les bases de lavabo FUSION.

Art. DX	Art. SX	mobile / base unit / élément bas
<b>R071</b>	<b>R072</b>	85 cm

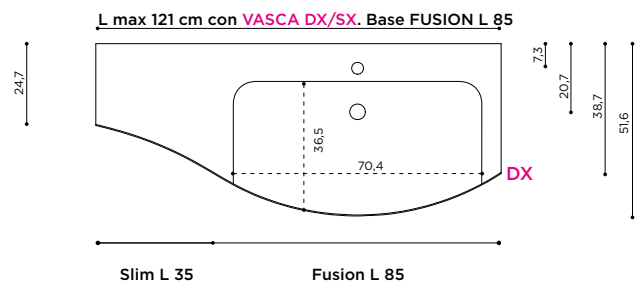

tekno deimos  
**Bianco**

tekno  
**Colore**

SKINNY  
Tekno Bianco



P/D  
**50**

**SLIM**  
Mineralguss



Piano top con lavabo integrato sp. 3,5 cm.  
Per basi portalavabo Fusion L 85

Top with built-in washbasin 3,5 cm thick  
For washbasin units Fusion W. 85 cm

Plan de toilette avec lavabo intégré ép. 3,5 cm.  
Pour éléments sous-lavabo Fusion L 85 cm

**Solo per basi portalavabo FUSION.**  
Only for FUSION washbasin units.  
Uniquement pour les bases de lavabo FUSION.



Art.	<b>mobile</b> / base unit / élément bas
<b>F309</b>	85 cm

L max 96 cm con **VASCA DX/SX**. Base FUSION L 85

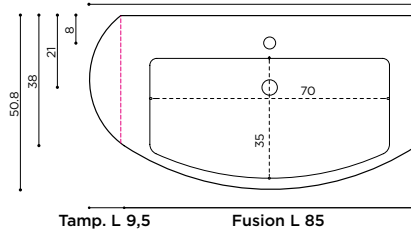

Art.	<b>mobile</b> / base unit / élément bas
<b>F308</b>	85 cm

L max 146 cm con **VASCA DX/SX**. Base FUSION L 85

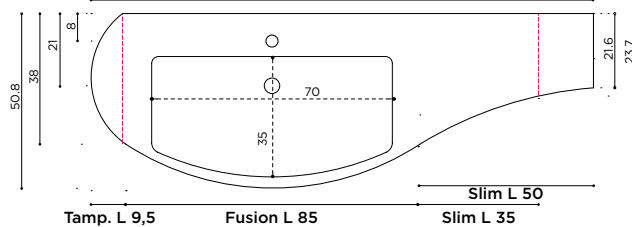

P/D  
50

# ZERO

Mineralguss



Piano top con lavabo integrato sp. 2,3 cm.  
Per basi portalavabo Fusion L 85 cm

Top with built-in washbasin 2.3 cm thick  
For Fusion washbasin units W. 85 cm

Plan de toilette avec lavabo intégré ép. 2,3 cm.  
Pour éléments sous-lavabo Fusion L. 85 cm

**Solo per basi portalavabo FUSION.**  
Only for FUSION washbasin units.  
Uniquement pour les bases de lavabo FUSION.

Art.	mobile / base unit / élément bas
<b>F002</b>	85 cm

Mineralguss  
Bianco

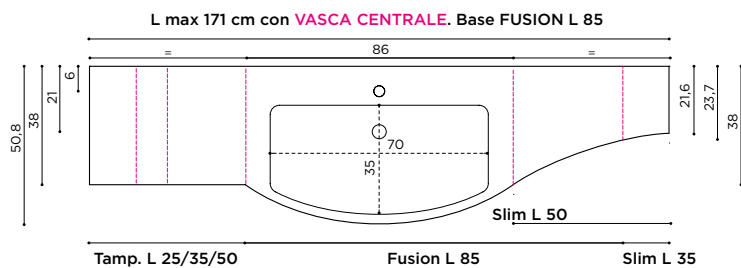

NUT RETTANGOLARE 60  
Tekno Colore Mostarda



04.

---

# PIANI CON LAVABI INTEGRATI

---

TOPS WITH BUILT-IN  
WASHBASINS

PLANS AVEC LABABOS  
INTEGREES

P/D  
37

# KREO

Mineralguss - Tekno



Piano top con lavabo integrato sp. 1,2 cm.  
Per basi portalavabo semincasso min. L 70 x  
P 37 cm

Top with built-in washbasin 1.2 cm thick  
Use for semi-recessed washbasin units min. W  
70 x D 37 cm

Plan de toilette avec lavabo intégré ép. 1,2 cm.  
Pour éléments sous-lavabo semi-encastées min.  
L 70 x P 37 cm

mineralguss  
Bianco

tekno  
Bianco

tekno  
Colore

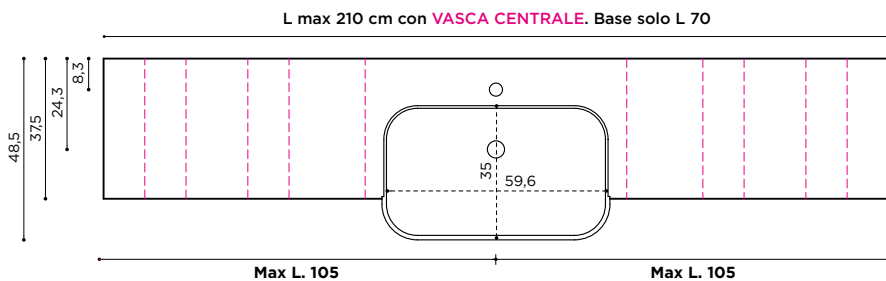
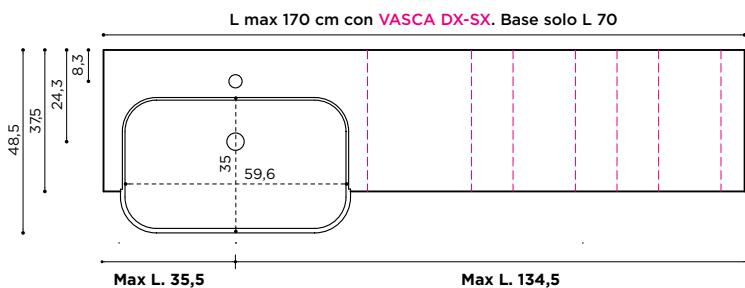

P/D  
37

# LOFT

Mineralguss



Piano top con lavabo integrato sp. 1,5 cm.  
Per basi portalavabo semincasso min. L 70 x  
P 37 cm

Top with built-in washbasin 1.5 cm thick  
Use for semi-recessed washbasin units min. W  
70 x D 37 cm

Plan de toilette avec lavabo intégré ép. 1,5 cm.  
Pour éléments sous-lavabo semi-encastrés min.  
L 70 x P 37 cm

mineralguss  
Bianco

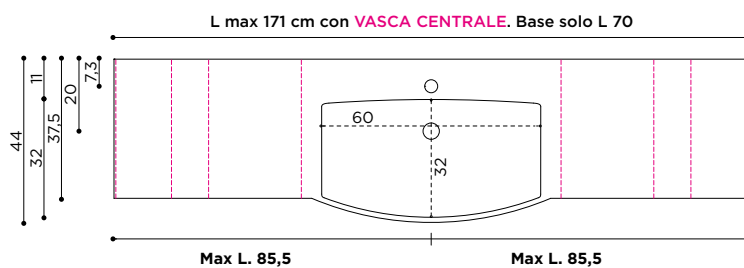
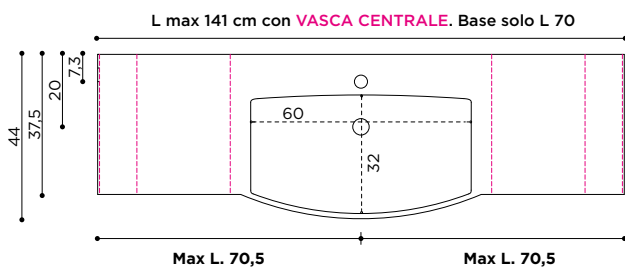
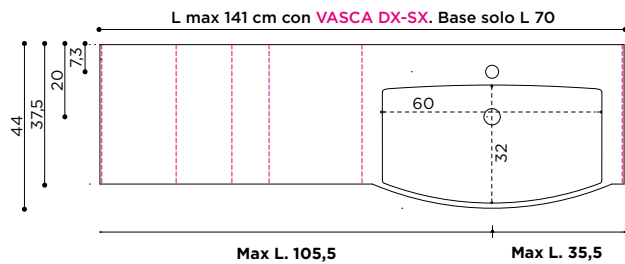

P/D  
37

## MILO

Mineralguss - Tekno Geacril



**Piano top con lavabo integrato sp. 1,2 cm.**  
**Per basi portalavabo dritte min. L 60 x P 37 cm (mix a muro)**  
**L 70 x P 37 cm (mix a laterale)**

Top with built-in washbasin 1.2 cm thick  
 Use for straight washbasin units min. W 60 x D 37 cm (wall mix)  
 W 70 x D 37 cm (side mix)

Plan de toilette avec lavabo intégré ép. 1,2 cm.  
 Pour éléments sous-lavabo min. L 60 x P 37 cm (mitigeur mural)  
 L 70 x P 37 cm (mitigeur latéral)

mineralguss  
Bianco

tekno  
Bianco

tekno  
Colore

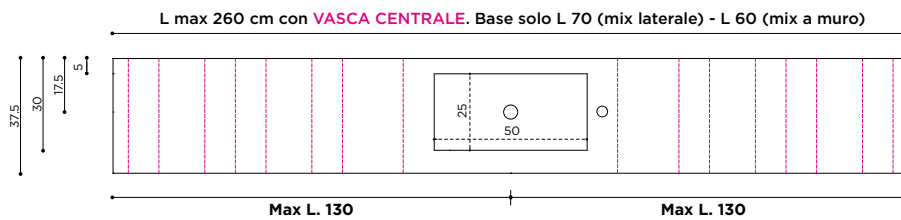

P/D  
37

## BLOCK

Cristalplant



**Piano top con lavabo integrato sp. 1,5 cm.**  
**Per basi portalavabo min. L 70 x P 37 cm**

Top with built-in washbasin 1.5 cm thick  
 Use for washbasin units min. W 70 x D 37 cm

Plan de toilette avec lavabo intégré ép. 1,5 cm.  
 Pour éléments sous-lavabo min. L 70 x P 37 cm

cristalplant  
Bianco

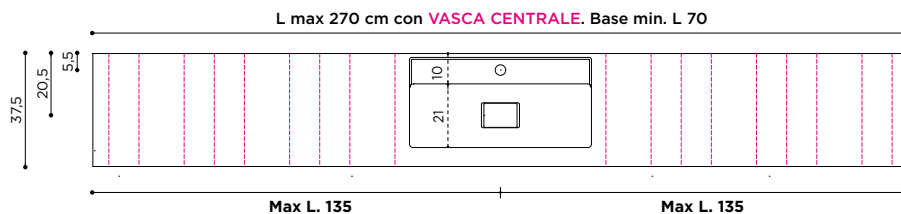

BLOCK  
Cristalplant



P/D  
**37**

# BLIP SEMINCASSO

Tekno Deimos



Piano top con lavabo integrato sp. 1,2 cm.  
Per basi portalavabo semincasso min. L 60 x P 37 cm

Top with built-in washbasin 1.2 cm thick  
Use for semi-recessed washbasin units min. W 60 x D 37 cm

Plan de toilette avec lavabo intégré ép. 1,2 cm.  
Pour éléments sous-lavabo semi-encastrés min. L 60 x P 37 cm

tekno deimos  
**Bianco**

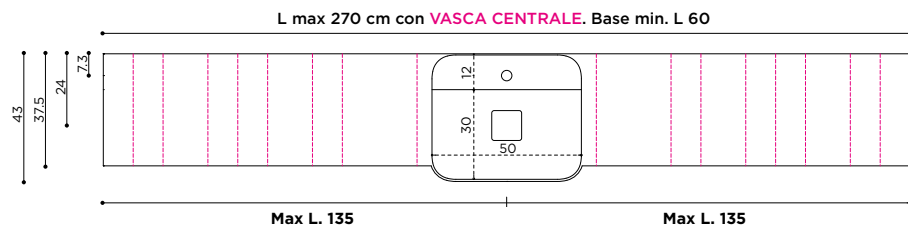

P/D  
**45**

# CLOE

Corian



Piano top con lavabo integrato sp. 1,2 - 8 - 12,2 cm.  
Per basi portalavabo dritte min. L 60 x P 45 cm (per Sp. 1,2 cm)  
L 70 x P 45 cm (per Sp. 8-12,2 cm)

Top with built-in washbasin 1.2 - 8 - 12.2 cm thick  
Use for straight washbasin units min. W 60 x D 45 cm (for th. 1.2 cm)  
W 70 x D 45 cm (for th. 8-12.2 cm)

Plan de toilette avec lavabo intégré ép. 1,2 - 8 - 12,2 cm.  
Pour éléments sous-lavabo droites min. L 60 x P 45 cm (pour ép. 1,2 cm)  
L 70 x P 45 cm (pour ép. 8-12,2 cm)

corian  
**Bianco**

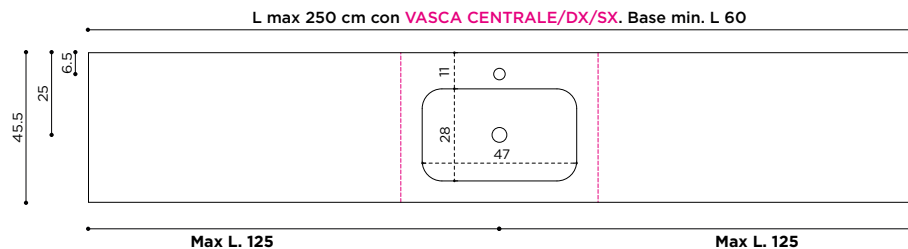

# FINITURE / FINISHES/ FINITIONS

## Nemi-Vico, Kuki-Naxos-Plaza, Slot-Riga

### OCRITECH\*

\* Solo per Kuki-Naxos-Plaza  
For Kuki-Naxos-Plaza only  
Uniquement pour Kuki-Naxos-Plaza



OCRITECH  
E1 Bianco opaco

### MINERALGUSS



Mineralguss  
MG Bianco lucido

### TEKNO TEKNO COLORE



Tekno  
E1 Bianco opaco



Tekno colore  
E9 xolare opaco  
(mazz. Arbi no metal)

### CATEGORIA 5 LAMINAM GRES



Laminam  
AA Fokos Sale



Laminam  
AC Fokos Terra



Laminam  
AB Fokos Roccia



Laminam  
AD Fokos Piombo

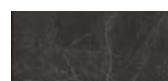

Laminam  
AI Nero Greco



Laminam  
AV Pietra Grey



Laminam  
AF Pietra di S. Perla



Laminam  
AE Pietra di S. Grigia



Laminam  
AG Pietra di S. Antracite

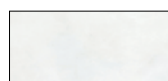

Laminam  
DJ Calce Bianco



Laminam  
DW Ossido Bruno



Laminam  
DV Ossido Nero



Laminam  
A9 Oxide Bianco



Laminam  
A4 Oxide Nero



Laminam  
DU Ossido verderame

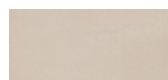

GRES Iris  
AJ Ivory

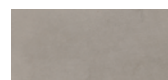

GRES Iris  
AL Silver



GRES Iris  
AM Amber

### CATEGORIA 6 LAMINAM GRES



Laminam  
D0 Bianco Assoluto  
opaco



Laminam  
DM Pietra Piasentina



Laminam  
DN Calacatta Oro  
Venato



Laminam  
DO Bianco Statuario  
Venato



Laminam  
DQ Ardesia Spacco  
Bianco



Laminam  
DR Ardesia Spacco  
Nero



Laminam  
DS Pietra di Cardoso  
Nero



Laminam  
DT Pietra di Cardoso  
Grigio



GRES  
DX Iseo Abujardado

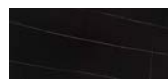

GRES  
DY Azalai Negro



Laminam  
AX Statuarietto

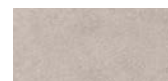

Laminam  
D3 Terra di Matera



Laminam  
D4 Terra di Saturnia



GRES Iris  
D7 Marsala



GRES Iris  
D8 Azure



GRES Iris  
D9 Steel Blue



GRES Iris  
D6 Green



Laminam  
L1 Alaska



Laminam  
L3 Ankara



Laminam  
L2 Amazzonia



Laminam  
L0 Burgundy



Laminam  
L4 Vulcano

### CATEGORIA 7 LAMINAM LUCIDO



Laminam  
AY Noir Desir Lucido



Laminam  
D5 Verde Alpi Lucido

### CATEGORIA 8 QUARZO RESINA



Quarzo resina  
OG Classic



Quarzo resina  
OH Charcoal



Quarzo resina  
OI Drak

04. Piani con lavabi integrati / Tops with built-in washbasins / Plans avec lavabos intégrées



NEMI  
Gres Iris Azure

P/D  
45

# NEMI - VICO

Mineralguss, Tekno bianco e colore, Laminam e Gres



Sp./Th./Ép. 1,2 cm



Sp./Th./Ép. 8 cm



Sp./Th./Ép. 12,2 cm

## NEMI

Piano top per basi portalavabo  
min. L 60 x P 45 cm (per sp. 1,2 cm)  
min. L 70 x P 45 cm (per sp. 8-12.2 cm)

Top for washbasin units  
min. W 60 x D 45 cm (for thick 1.2 cm)  
min. W 70 x D 45 cm (for thick 8-12.2 cm)

Plan de toilette pour éléments sous-lavabo  
min. L 60 x P 45 cm (pour ép. 1,2 cm)  
min. L 70 x P 45 cm (pour ép. 8-12,2 cm)

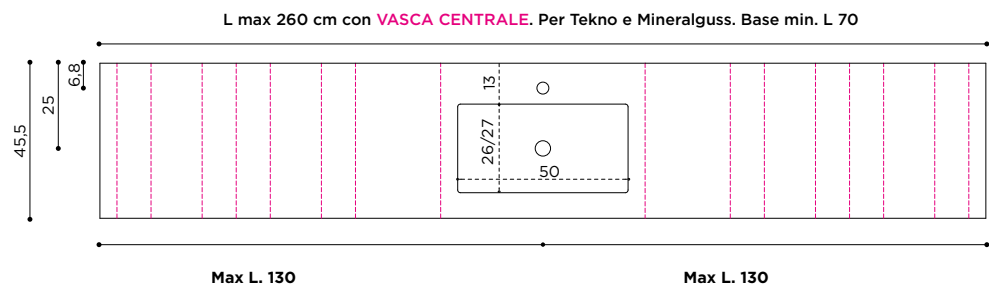

## VICO

Piano top per basi portalavabo  
min. L 70 x P 45 cm (per sp. 1,2 cm)  
min. L 80 x P 45 cm (per sp. 8 - 12.2 cm)

Top for washbasin units  
min. W 70 x D 45 cm (for thick 1.2 cm)  
min. W 80 x D 45 cm (for thick 8 - 12.2 cm)

Plan de toilette pour éléments sous-lavabo  
min. L 70 x P 45 cm (pour ép. 1,2 cm)  
min. L 80 x P 45 cm (pour ép. 8 - 12,2 cm)

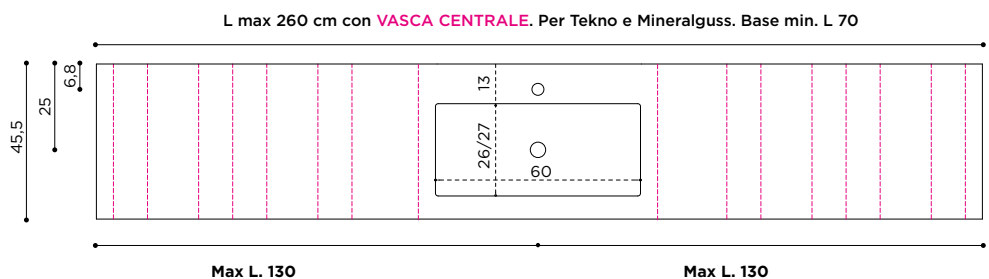



MAGNUM  
Ocritch

P / D  
45

# MAGNUM

Ocritech

NEW

## MAGNUM 50

Piano top per basi portalavabo L 60 x P 45 cm (per sp. 1,2 cm)  
L 70 x P 45 cm (per sp. 8-12,2 cm)

Top for washbasin units min. W 60 x D 45 cm (for thick 1.2 cm)  
min. W 70 x D 45 cm (for thick 8-12.2 cm)

Plan de toilette pour éléments sous-lavabo min. L 60 x P 45 cm  
(pour ép. 1,2 cm)  
min. L 70 x P 45 cm (pour ép. 8-12,2 cm)

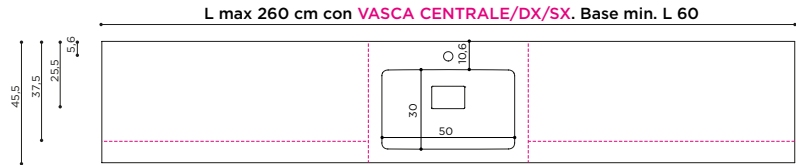

## MAGNUM 60

Piano top per basi portalavabo L 70 x P 45 cm (per sp. 1,2 cm)  
L 85 x P 45 cm (per sp. 8-12,2 cm)

Top for washbasin units min. W 70 x D 45 cm (for thick 1.2 cm)  
min. W 85 x D 45 cm (for thick 8-12.2 cm)

Plan de toilette pour éléments sous-lavabo min. L 70 x P 45 cm  
(pour ép. 1,2 cm)  
min. L 85 x P 45 cm (pour ép. 8-12,2 cm)

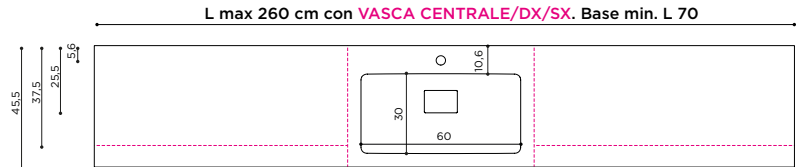

## MAGNUM 70

Piano top per basi portalavabo L 85 x P 45 cm

Top for washbasin units min. W 85 x D 45 cm

Plan de toilette pour éléments sous-lavabo min. L 85 x P 45 cm

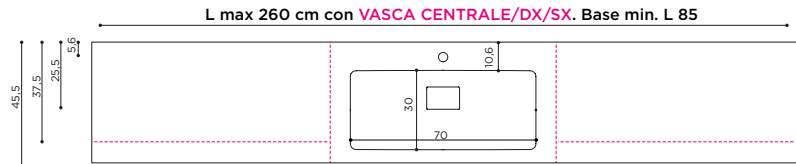

P / D  
50

# MAGNUM

Ocritech

NEW

## MAGNUM 50

Piano top per basi portalavabo L 60 x P 50 cm (per sp. 1,2 cm)  
L 70 x P 50 cm (per sp. 8-12,2 cm)

Top for washbasin units min. W 60 x D 50 cm (for thick 1.2 cm)  
min. W 70 x D 50 cm (for thick 8-12.2 cm)

Plan de toilette pour éléments sous-lavabo min. L 60 x P 50 cm  
(pour ép. 1,2 cm)  
min. L 70 x P 50 cm (pour ép. 8-12,2 cm)

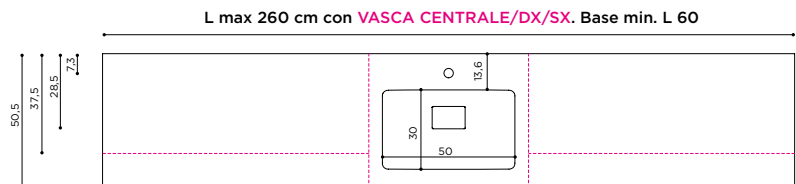

## MAGNUM 60

Piano top per basi portalavabo L 70 x P 50 cm (per sp. 1,2 cm)  
L 85 x P 50 cm (per sp. 8-12,2 cm)

Top for washbasin units min. W 70 x D 50 cm (for thick 1.2 cm)  
min. W 85 x D 50 cm (for thick 8-12.2 cm)

Plan de toilette pour éléments sous-lavabo min. L 70 x P 50 cm  
(pour ép. 1,2 cm)  
min. L 85 x P 50 cm (pour ép. 8-12,2 cm)

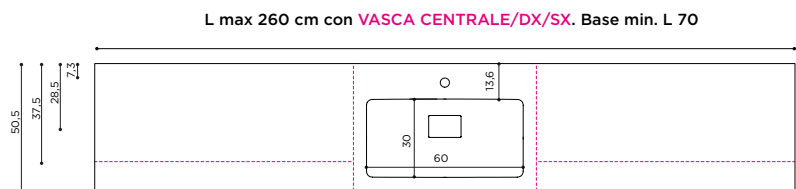

## MAGNUM 70

Piano top per basi portalavabo L 85 x P 50 cm

Top for washbasin units min. W 85 x D 50 cm

Plan de toilette pour éléments sous-lavabo min. L 85 x P 50 cm

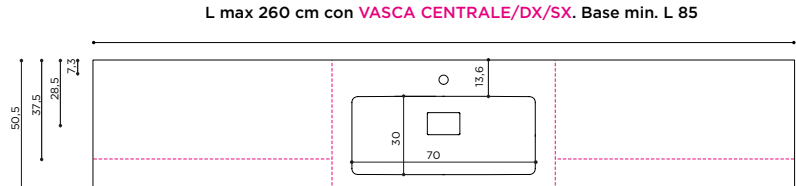

P/D  
50

# NOTES

Cristalplant

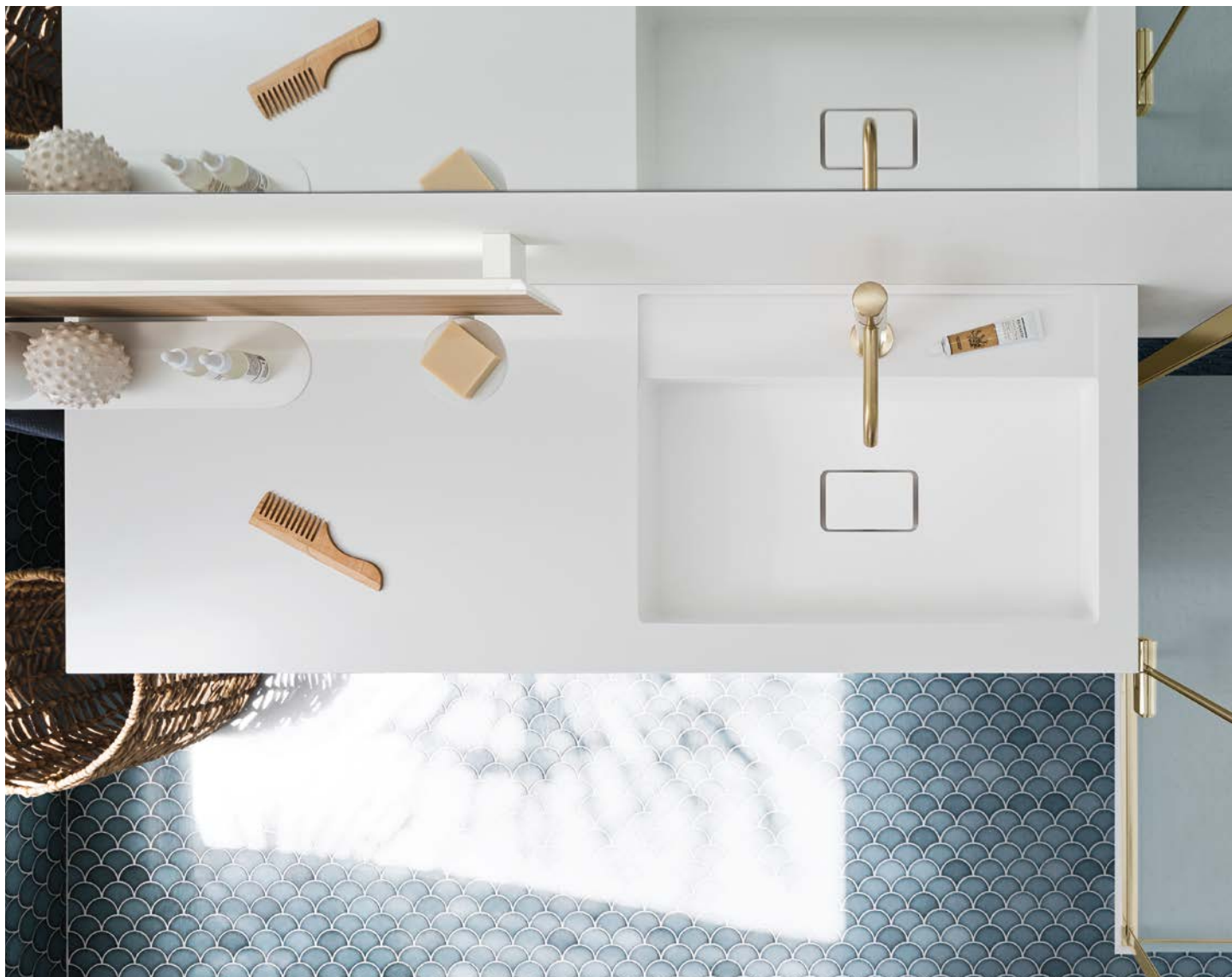

Piano top con lavabo integrato sp. 1,5 cm.  
Per basi portavavabo min. L 70 x P 50 cm

Top with built-in washbasin 1.5 cm thick  
Use for washbasin units min. W 70 x D 50 cm

Plan de toilette avec lavabo intégré ép. 1,5 cm.  
Pour éléments sous-lavabo min. L 70 x P 50 cm

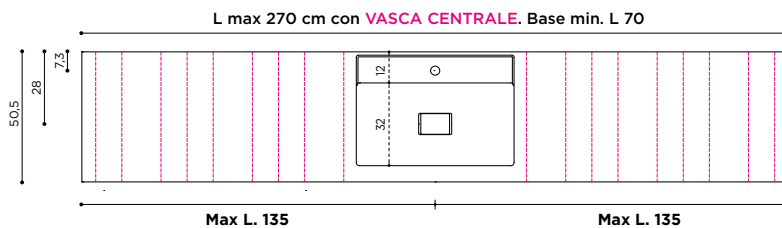

cristalplant  
Bianco

P/D  
50

# CURVY

Mineralguss

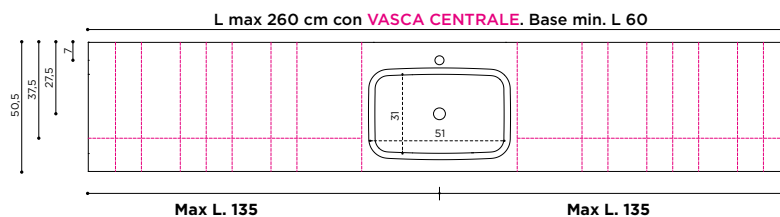

mineralguss  
Bianco

Piano top con lavabo integrato sp. 1,2 cm.  
Per basi portalavabo min. L 60 x P 50 cm

Top with built-in washbasin 1.2 cm thick  
Use for washbasin units min. W 60 x D 50 cm

Plan de toilette avec lavabo intégré ép. 1,2 cm.  
Pour éléments sous-lavabo min. L 60 x P 50 cm

P/D  
50

# JOY

Mineralguss

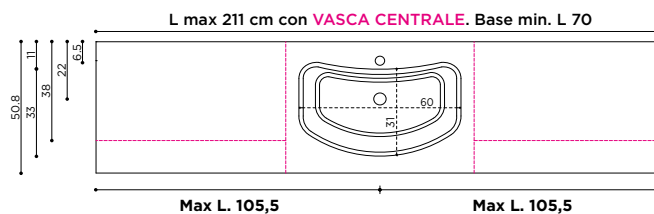
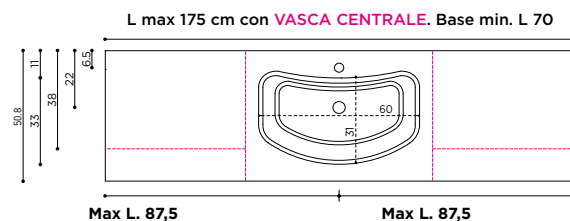

Piano top con lavabo integrato sp. 1,4 cm.  
Per basi portalavabo min. L 70 x P 50 cm

Top with built-in washbasin 1.4 cm thick  
Use for washbasin units min. W 70 x D 50 cm

Plan de toilette avec lavabo intégré ép. 1,4 cm.  
Pour éléments sous-lavabo min. L 70 x P 50 cm

mineralguss  
Bianco

P/D  
50

# JOKER

Mineralguss



Piano top con lavabo integrato sp. 1,4 cm.  
Per basi portalavabo min. L 85 x P 50 cm

Top with built-in washbasin 1.4 cm thick  
Use for washbasin units min. W 85 x D 50 cm

Plan de toilette avec lavabo intégré ép. 1,4 cm.  
Pour éléments sous-lavabo min. L 85 x P 50 cm

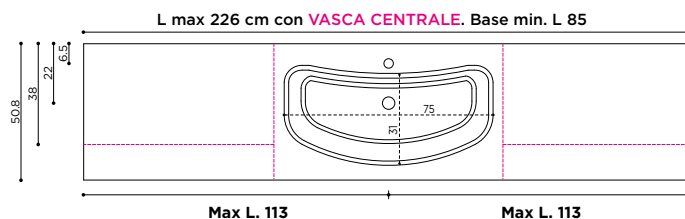
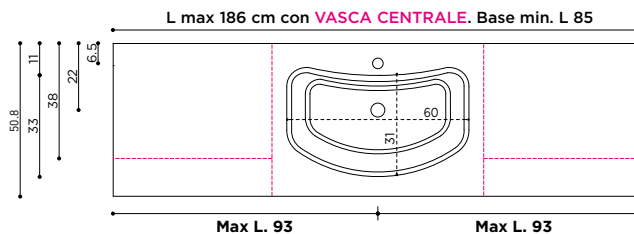

mineralguss

Bianco

Art.	mobile / base unit / élément bas
<b>F702</b>	85 cm

Art.	mobile / base unit / élément bas
<b>F802</b>	85 cm

P/D  
50

# BLIP

Tekno Deimos



Piano top con lavabo integrato sp. 1,2 cm.  
Per basi portalavabo min. L 70 x P 50 cm

Top with built-in washbasin 1.2 cm thick  
Use for washbasin units min. W 70 x D 50 cm

Plan de toilette avec lavabo intégré ép. 1,2 cm.  
Pour éléments sous-lavabo min. L 70 x P 50 cm

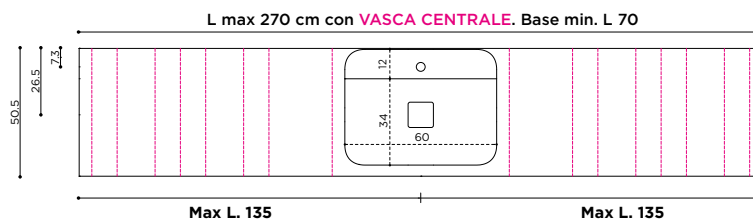

Tekno Deimos

Bianco

P/D  
50

# WALL 50-60

Tekno Resina

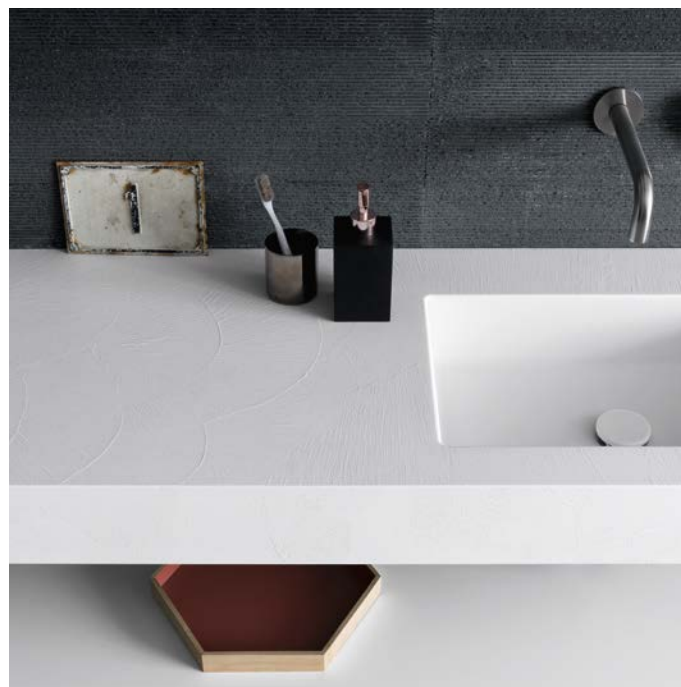

## WALL 50

Piano top per basi portalavabo  
min. L 60 x P 50 cm (per sp. 1,2 cm)  
min. L 70 x P 50 cm (per sp. 8-12,2 cm)

Top for washbasin units  
min. W 60 x D 50 cm (for thick 1.2 cm)  
min. W 70 x D 50 cm (for thick 8-12.2 cm)

Plan de toilette pour éléments sous-lavabo  
min. L 60 x P 50 cm (pour ép. 1,2 cm)  
min. L 70 x P 50 cm (pour ép. 8-12,2 cm)

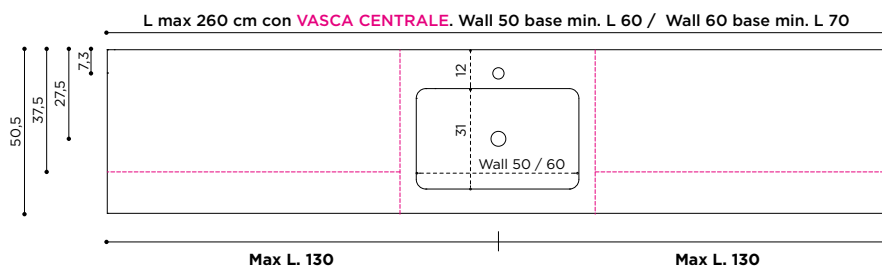

## WALL 60

Piano top per basi portalavabo  
min. L 70 x P 50 cm (per sp. 1,2 cm)  
min. L 85 x P 50 cm (per sp. 8-12,2 cm)

Top for washbasin units  
min. W 70 x D 50 cm (for thick 1.2 cm)  
min. W 85 x D 50 cm (for thick 8-12.2 cm)

Plan de toilette pour éléments sous-lavabo  
min. L 70 x P 50 cm (pour ép. 1,2 cm)  
min. L 85 x P 50 cm (pour ép. 8-12,2 cm)



P/D  
50

# NUT

Tekno Deimos bianco e Tekno colore

NEW



## NUT OVALE & RETTANGOLARE 48

Piano top per basi portalavabo  
min. L 60 x P 50 cm (per sp. 1,2 cm)  
min. L 70 x P 50 cm (per sp. 8-12,2 cm)

Top for washbasin units  
min. W 60 x D 50 cm (for thick 1.2 cm)  
min. W 70 x D 50 cm (for thick 8-12.2 cm)

Plan de toilette pour éléments sous-lavabo  
min. L 60 x P 50 cm (pour ép. 1,2 cm)  
min. L 70 x P 50 cm (pour ép. 8-12,2 cm)

## NUT OVALE & RETTANGOLARE 60

Piano top per basi portalavabo  
min. L 70 x P 50 cm (per sp. 1,2 cm)  
min. L 85 x P 50 cm (per sp. 8-12,2 cm)

Top for washbasin units  
min. W 70 x D 50 cm (for thick 1.2 cm)  
min. W 85 x D 50 cm (for thick 8-12.2 cm)

Plan de toilette pour éléments sous-lavabo  
min. L 70 x P 50 cm (pour ép. 1,2 cm)  
min. L 85 x P 50 cm (pour ép. 8-12,2 cm)

tek. deimos  
Bianco

tekno  
Colore

NUT OVALE 48: L max 260 cm con VASCA CENTRALE. Base min. L 60  
NUT OVALE 60: L max 260 cm con VASCA CENTRALE. Base min. L 70

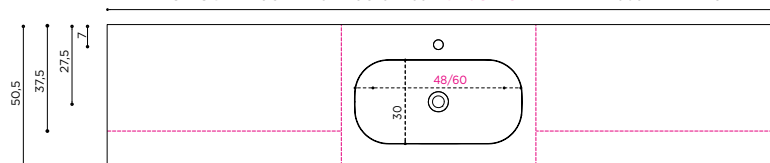

NUT RETTANGOLARE 48: L max 260 cm con VASCA CENTRALE. Base min. L 60  
NUT RETTANGOLARE 60: L max 260 cm con VASCA CENTRALE. Base min. L 70

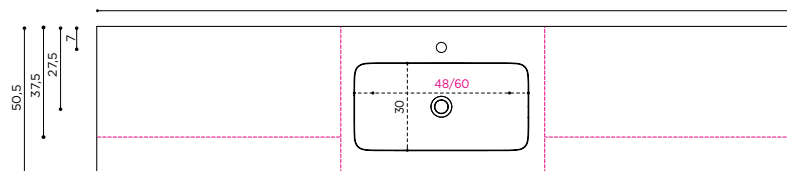

NUT OVALE 48  
Tekno Deimos Bianco



P/D  
**50**

# YPSILON 50-70

Mineralguss, Tekno Deimos



tek, Deimos  
**Bianco**  
opaco

mineralguss  
**Bianco**  
lucido

## YPSILON 50

**Piano top con lavabo integrato sp. 1,5/2,6 cm.  
Per basi portalavabo min. L 60 x P 50 cm**

Top with built-in washbasin 1.5/2.6 cm thick.  
Top for washbasin units min. W 60 x D 50 cm

Plan de toilette avec lavabo intégré ép. 1,2 cm.  
Plan de toilette pour éléments sous-lavabo min.  
L 60 x P 50 cm

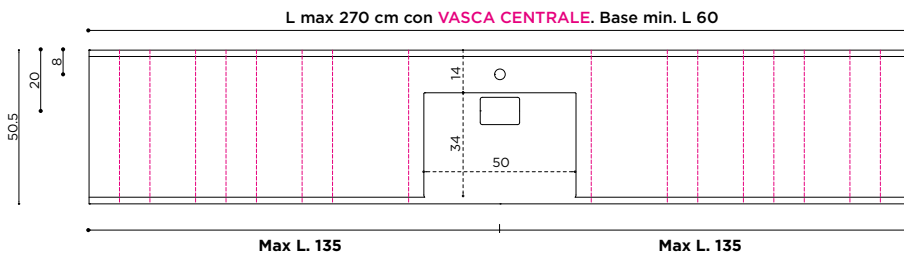

## YPSILON 70

**Piano top con lavabo integrato sp. 1,5/2,6 cm.  
Per basi portalavabo min. L 85 x P 50 cm**

Top with built-in washbasin 1.5/2.6 cm thick  
Top for washbasin units min. W 85 x D 50 cm

Plan de toilette avec lavabo intégré ép. 1,2 cm.  
Plan de toilette pour éléments sous-lavabo min.  
L 85 x P 50 cm

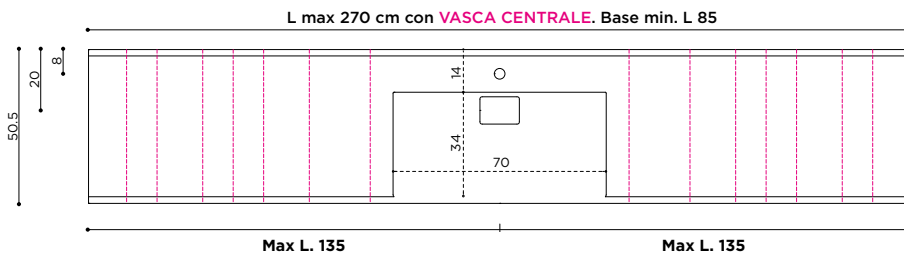

P/D  
50

# KUKI, NAXOS, PLAZA

Ocritch, Mineralguss, Tekno e Tekno Colore, Laminam e Gres, Quarzo Resina

NAXOS  
Laminam Verde Alpi Lucido

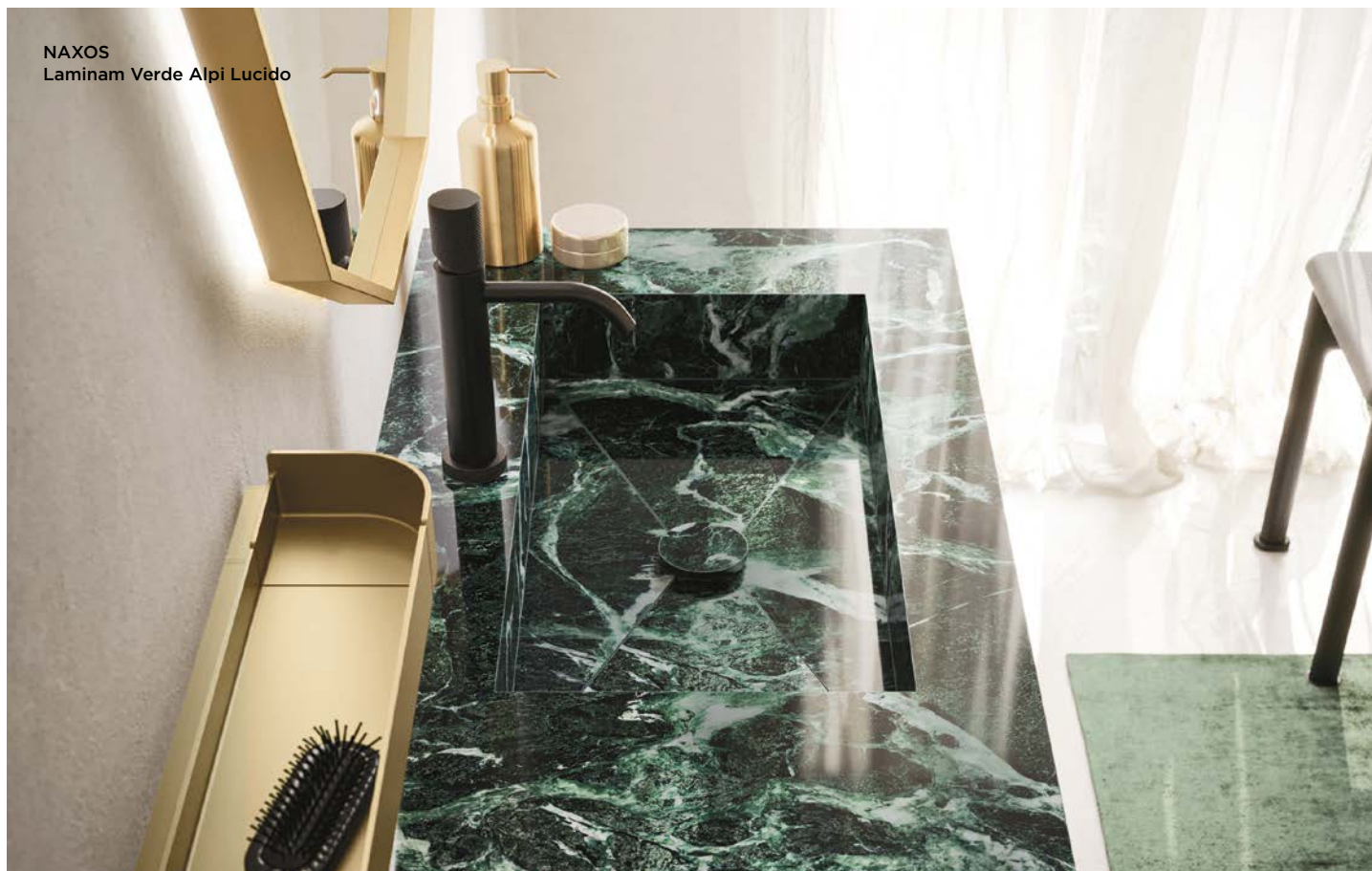

## KUKI

Piano top per basi portalavabo min. L 60 x P 50 cm (per sp. 1,2 cm)  
min. L 70 x P 50 cm (per sp. 8-12,2 cm)

Top for washbasin units min. W 60 x D 50 cm (for thick 1.2 cm)  
min. W 70 x D 50 cm (for thick 8-12.2 cm)

Plan de toilette pour éléments sous-lavabo min. L 60 x P 50 cm (pour ép. 1,2 cm)  
min. L 70 x P 50 cm (pour ép. 8-12,2 cm)

L max 260 cm con **VASCA CENTRALE**. Per Mineralguss e Tekno. base min. L 60

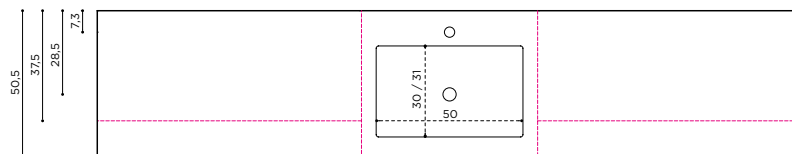

04. Piani con lavabi integrati / Tops with built-in washbasins / Plans avec lavabos intégrées



**NAXOS**

Piano top per basi portalavabo min. L 70 x P 50 cm (per sp. 1,2 cm)  
 min. L 85 x P 50 cm (per sp. 8-12,2 cm)

Top for washbasin units min. W 70 x D 50 cm (for thick 1.2 cm)  
 min. W 85 x D 50 cm (for thick 8-12.2 cm)

Plan de toilette pour éléments sous-lavabo min. L 70 x P 50 cm (pour ép. 1,2 cm)  
 min. L 85 x P 50 cm (pour ép. 8-12,2 cm)

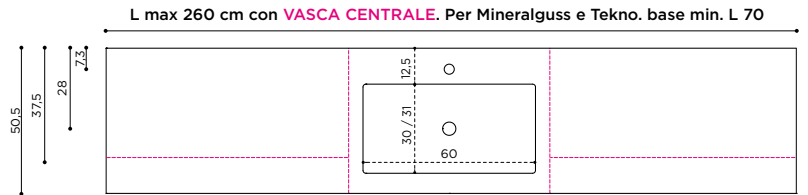

**PLAZA**

Piano top per basi portalavabo min. L 85 x P 50 cm

Top for washbasin units min. W 85 x D 50 cm

Plan de toilette pour éléments sous-lavabo min. L 85 x P 50 cm

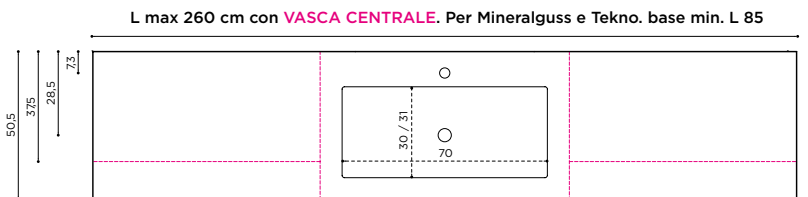

P/D  
50

# PLUG - STOPPER

Mineralguss, Tekno bianco e colore, HPL, Fenix

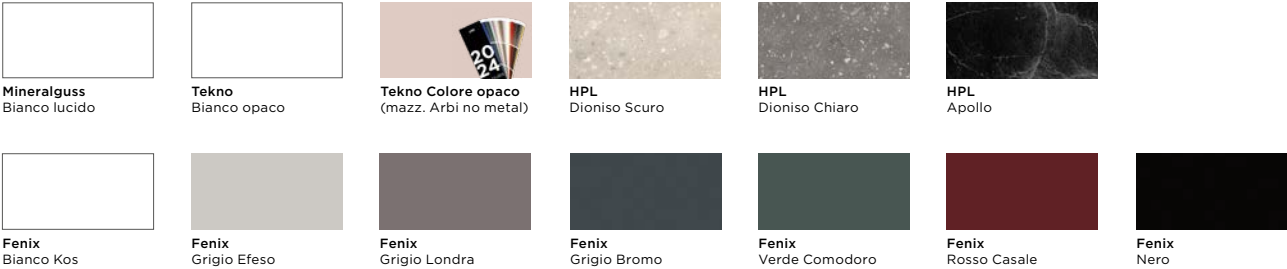

## PLUG

Piano top per basi portalavabo  
min. L 60 x P 50 cm (per sp. 1,2 cm)  
min. L 70 x P 50 cm (per sp. 8-12,2 cm)

Top for washbasin units  
min. W 60 x D 50 cm (for thick 1.2 cm)  
min. W 70 x D 50 cm (for thick 8-12.2 cm)

Plan de toilette pour éléments sous-lavabo  
min. L 60 x P 50 cm (pour ép. 1,2 cm)  
min. L 70 x P 50 cm (pour ép. 8-12,2 cm)

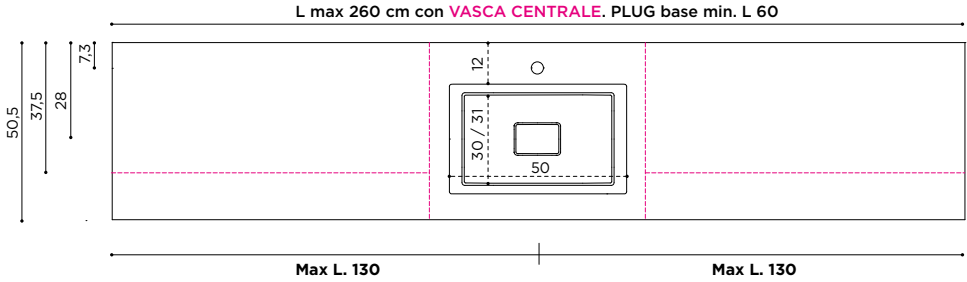

## STOPPER

Piano top per basi portalavabo  
min. L 85 x P 50 cm

Top for washbasin units  
min. W 85 x D 50 cm

Plan de toilette pour éléments sous-lavabo min. L 85 x P 50 cm

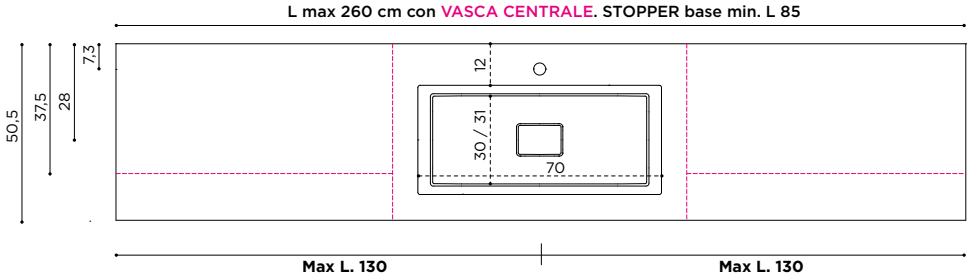

P/D  
**50**

# SLOT - RIGA

Mineralguss, Tekno e Tekno Colore, Laminam e Gres, Quarzo Resina



## SLOT

Piano top per basi portalavabo  
 min. L 60 x P 50 cm (per sp. 1,2 cm)  
 min. L 70 x P 50 cm (per sp. 8-12,2 cm)

Top for washbasin units  
 min. W 60 x D 50 cm (for thick 1.2 cm)  
 min. W 70 x D 50 cm (for thick 8-12.2 cm)

Plan de toilette pour éléments sous-lavabo  
 min. L 60 x P 50 cm (pour ép. 1,2 cm)  
 min. L 70 x P 50 cm (pour ép. 8-12,2 cm)

## RIGA

Piano top per basi portalavabo  
 min. L 85 x P 50 cm

Top for washbasin units min.  
 W 85 x D 50 cm

Plan de toilette pour éléments sous-lavabo  
 min. L 85 x P 50 cm

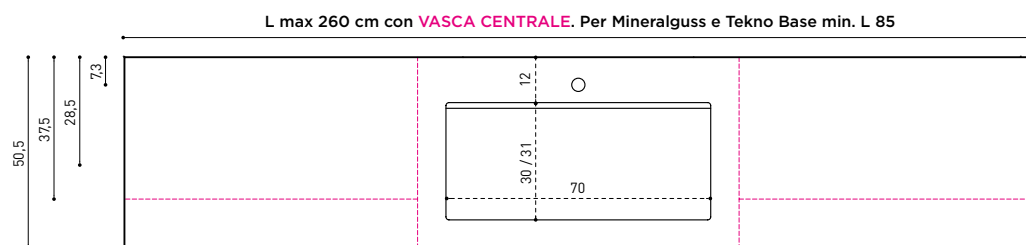
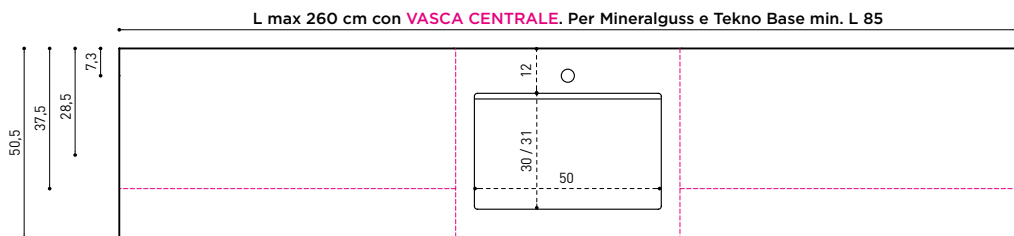

SLOT  
Laminam ossido Verderame



P/D  
50

## RETTANGOLARE

Corian



Piano top per basi portalavabo min. L 70 x P 50 cm (per sp. 1,2 cm)  
min. L 85 x P 50 cm (per sp. 8-12,2 cm)

Top for washbasin units min. W 70 x D 50 cm (for thick 1.2 cm)  
min. W 85 x D 50 cm (for thick 8-12.2 cm)

Plan de toilette pour éléments sous-lavabo min. L 70 x P 50 cm (pour ép. 1,2 cm)  
min. L 85 x P 50 cm (pour ép. 8-12,2 cm)

corian  
Bianco

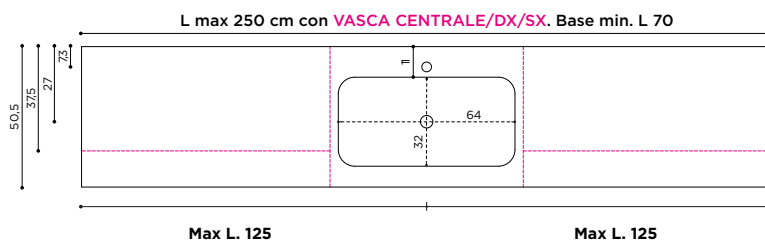

P/D  
50

## OVALE 65

Corian



Piano top con lavabo integrato sp. 1,2 cm.  
Per basi portalavabo min. L 70 x P 50 cm

Top with built-in washbasin 1.2 cm thick  
Use for washbasin units min. W 70 x D 50 cm

Plan de toilette avec lavabo intégré ép. 1,2 cm.  
Pour éléments sous-lavabo min. L 70 x P 50 cm

corian  
Bianco

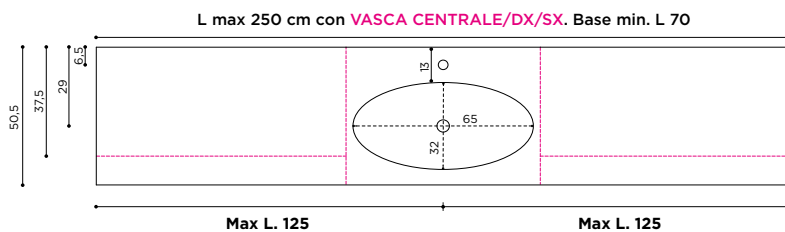

P/D  
50

# BOB

Corian



## BOB PICCOLO

Piano top con lavabo integrato sp. 1,2 cm.  
Per basi portalavabo min. L 70 x P 50 cm

Top with built-in washbasin 1.2 cm thick  
Use for washbasin units min. W 70 x D 50 cm

Plan de toilette avec lavabo intégré ép. 1,2 cm.  
Pour éléments sous-lavabo min. L 60 x P 50 cm

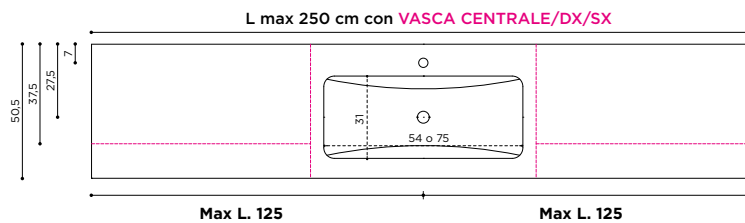

## BOB GRANDE

Piano top con lavabo integrato sp. 1,2 cm.  
Per basi portalavabo min. L 85 x P 50 cm

Top with built-in washbasin 1.2 cm thick  
Use for washbasin units min. W 85 x D 50 cm

Plan de toilette avec lavabo intégré ép. 1,2 cm.  
Pour éléments sous-lavabo min. L 85 x P 50 cm



P/D  
**50**

# FLY 50-60-70

Corian



**Piano top con lavabo integrato sp. 1 cm.**  
 Per basi portlavabo min. L 60 x P 50 cm (Fly 50)  
 min. L 70 x P 50 cm (Fly 60)  
 min. L 85 x P 50 cm (Fly 70)

corian  
**Bianco**

Top with built-in washbasin 1 cm thick  
 Use for washbasin units min. W 60 x D 50 cm (Fly 50)  
 min. W 70 x D 50 cm (Fly 60)  
 min. W 85 x D 50 cm (Fly 70)

Plan de toilette avec lavabo intégré ép. 1 cm.  
 Pour éléments sous-lavabo min. L 70 x P 50 cm (Fly 50)  
 min. L 70 x P 50 cm (Fly 60)  
 min. L 85 x P 50 cm (Fly 70)

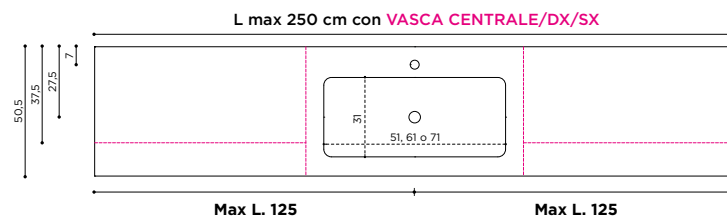

## FINITURE PIANI TOP IN CRISTALLO CRYSTAL TOP FINISHES/ FINITIONS PLANS EN VERRE

FINITURE CRISTALLO sp. 1 cm  
 LUCIDO e SATINATO IN TUTTI  
 I COLORI DELLA MAZETTA ARBI  
 per laccati metal solo Cristallo lucido



FINITURE SOLID GLASS:  
  
 NERO OPACO sp. 1 cm

Ovale 57  
Cristallo Carruba satinato

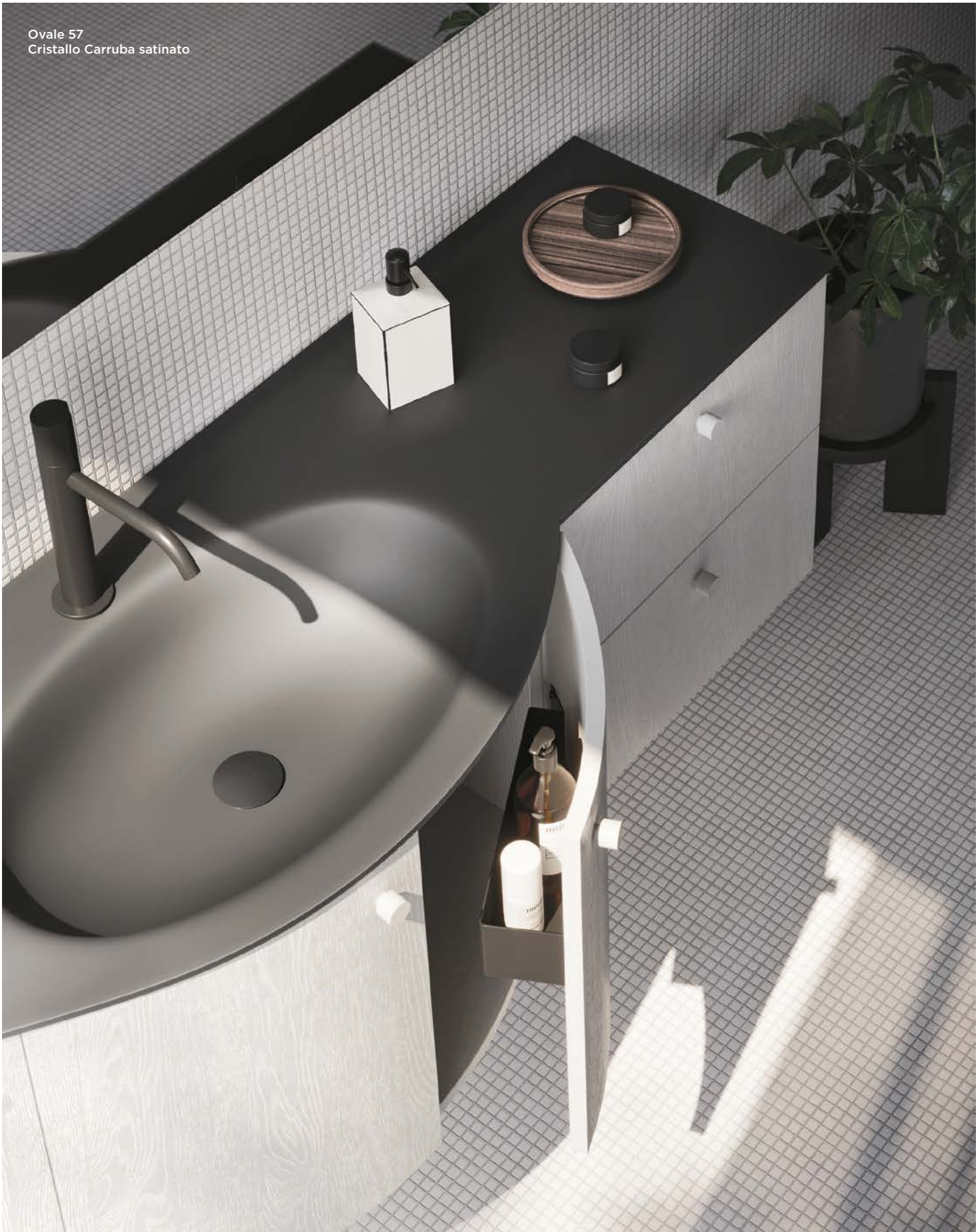

P/D  
50

## OVALE 57

Cristallo

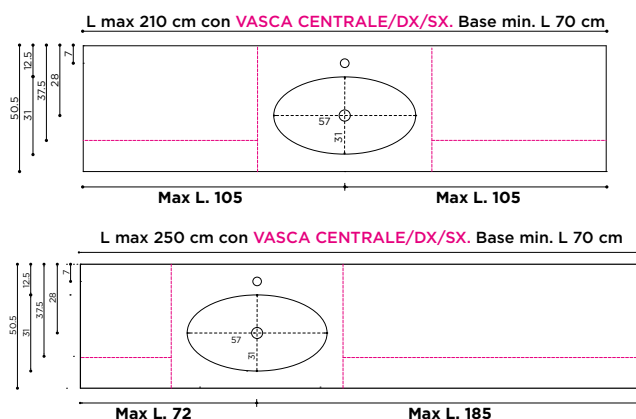

Piano top con lavabo integrato sp. 1 cm.  
Per basi portalavabo min. L 70 x P 50 cm

Top with built-in washbasin 1 cm thick  
Use for washbasin units min. W 70 x D 50 cm

Plan de toilette avec lavabo intégré ép. 1 cm.  
Pour éléments sous-lavabo min. L 70 x P 50 cm

P/D  
50

## AFRO

Cristallo

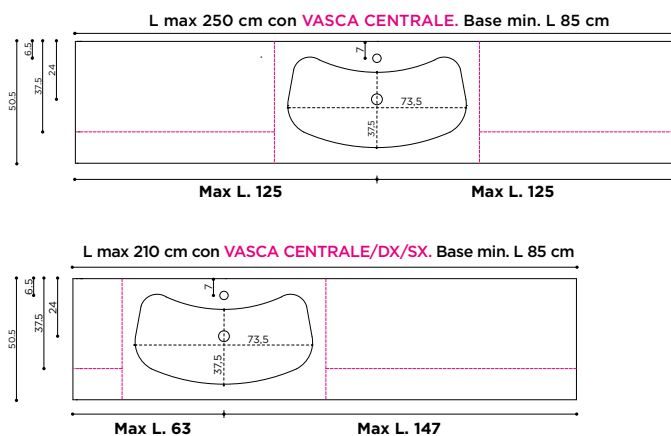

Piano top con lavabo integrato sp. 1 cm.  
Per basi portalavabo min. L 85 x P 50 cm

Top with built-in washbasin 1 cm thick  
Use for washbasin units min. W 85 x D 50 cm

Plan de toilette avec lavabo intégré ép. 1 cm.  
Pour éléments sous-lavabo min. L 85 x P 50 cm

P/D  
50

## DILVA

Cristallo

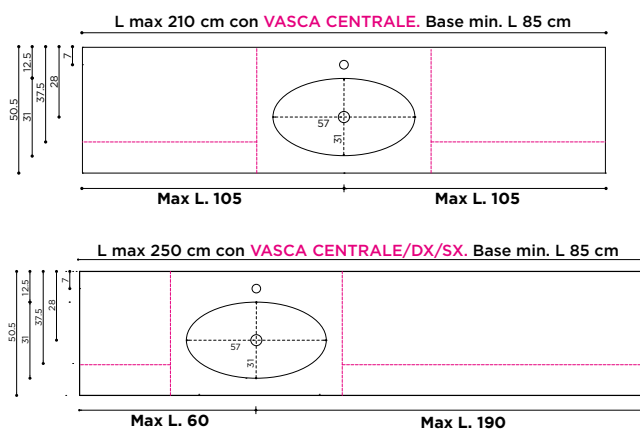

Piano top con lavabo integrato sp. 1 cm.  
Per basi portalavabo min. L 85 x P 50 cm

Top with built-in washbasin 1 cm thick  
Use for washbasin units min. W 85 x D 50 cm

Plan de toilette avec lavabo intégré ép. 1 cm.  
Pour éléments sous-lavabo min. L 85 x P 50 cm

P/D  
50

## RETTANGOLARE PICCOLO

Cristallo

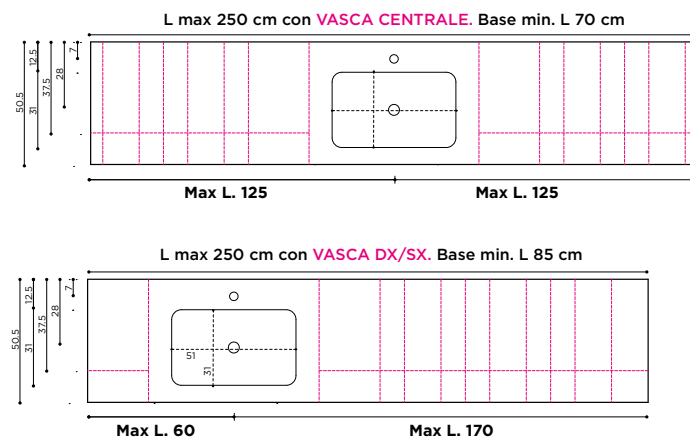

Piano top con lavabo integrato sp. 1 cm.  
Per basi portalavabo min. L 70 x P 50 cm

Top with built-in washbasin 1 cm thick  
Use for washbasin units min. W 70 x D 50 cm

Plan de toilette avec lavabo intégré ép. 1 cm.  
Pour éléments sous-lavabo min. L 70 x P 50 cm

TAPE  
laccato Londra 21 opaco



05.

# ACCESSORI

---

ACCESSORIES

ACCESSOIRES

# SLIDE

Alluminio / Aluminium

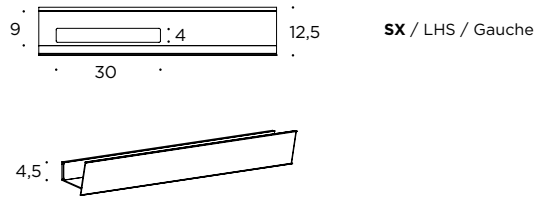

## Mensola Slide in alluminio con foro portaserviette L 30 x P 4 cm

Slide aluminium shelves with rail hole  
W. 30 x D. 4 cm

Étagères Slide en aluminium avec trou porte-serviettes  
L 30 x P 4 cm



## Mensola Slide in alluminio

Slide aluminium shelves

Étagères Slide en aluminium

### Misure disponibili (PxHxL) / Dimensions (DxHxW) / Mesures (PxHxL)

Art. DX	Art. SX	
<b>V143</b>	<b>V164</b>	12,5 x 10 x 70
<b>V265</b>	<b>V266</b>	12,5 x 10 x 85
<b>V145</b>	<b>V165</b>	12,5 x 10 x 120

### Misure disponibili (PxHxL) / Dimensions (DxHxW) / Mesures (PxHxL)

Art.	
<b>V146</b>	12,5 x 10 x 35
<b>V147</b>	12,5 x 10 x 50
<b>V148</b>	12,5 x 10 x 70
<b>V269</b>	12,5 x 10 x 85
<b>V270</b>	12,5 x 10 x 120

# SLIDE SAGOMATA

Alluminio / Aluminium

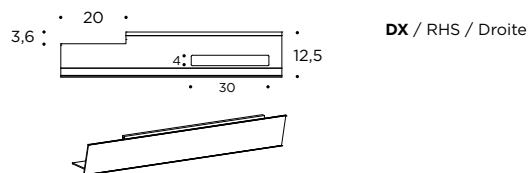

**Mensola Slide sagomata in alluminio con foro portasalviette L 30 x P 4 cm con scanso per affiancamento specchiera**

Slide shaped aluminium shelves with LHS or RHS towel rail hole  
W. 30 x D. 4 cm  
With shape for positioning mirrors side by side.

Étagères Slide façonnée en aluminium avec trou porte-serviettes  
L 30 x P 4 cm  
Avec découpe pour juxtaposition miroir.

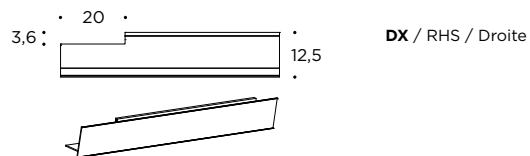

**Mensola Slide in alluminio con scanso per affiancamento specchiera**

Slide aluminium shelves  
With shape for positioning mirrors side by side.

Étagères Slide en aluminium  
Avec découpe pour juxtaposition miroir.

Misure disponibili (PxHxL) / Dimensions (DxHxW) / Mesures (PxHxL)

Art. DX	Art. SX	
<b>V257</b>	<b>V258</b>	12,5 x 10 x 70
<b>V267</b>	<b>V268</b>	12,5 x 10 x 85
<b>V259</b>	<b>V260</b>	12,5 x 10 x 120

Misure disponibili (PxHxL) / Dimensions (DxHxW) / Mesures (PxHxL)

Art. DX	Art. SX	
<b>V275</b>	<b>V276</b>	12,5 x 10 x 70
<b>V277</b>	<b>V278</b>	12,5 x 10 x 85
<b>V279</b>	<b>V280</b>	12,5 x 10 x 120

# TAPE

Alluminio / Aluminium



# TAPE

Alluminio / Aluminium



## Mensola porta oggetti P 11,2 x H 5 cm

Shelf for objects  
D. 11.2 x H. 5 cm

Étagère porte-objets  
P 11,2 x H 5 cm



## Mensola con foro L 26/41 cm portasalviette P 11,2 x H 5 cm

Shelf with hole W. 26 / 41 cm towel rail  
D. 11.2 x H. 5 cm

Étagère avec trou L 26 /41 cm porte-serviettes  
P 11,2 x H 5 cm

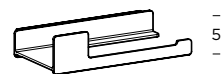

## Mensola porta rotolo (solo dx) P 11,2 x H 5 cm

Roll holder shelf (right only)  
D. 11.2 x H. 5 cm

Étagère porte-rouleau (seulement droite)  
P 11,2 x H 5 cm



**DX** / RHS / Droite

## Terminala per mensole dx-sx L 7,5 + 2,5 cm di innesto

End piece for shelves right-left  
W. 7.5 + 2.5 cm insertion

Terminal pour étagères droite-gauche  
L 7,5 + 2,5 de insertion

Nero

Bianco

Colore  
op. e metal



Misure disponibili (LxH) / Dimensions (WxH) / Mesures (LxH)

Art.	
<b>AV01</b>	35 x 11,2
<b>AV02</b>	50 x 11,2
<b>AV03</b>	70 x 11,2

Misure disponibili (LxH) / Dimensions (WxH) / Mesures (LxH)

Art.	
<b>AV04</b>	35 x 11,2
<b>AV05</b>	50 x 11,2

Misure disponibili (LxH) / Dimensions (WxH) / Mesures (LxH)

Art.	
<b>AV06</b>	20 x 11,2

Misure disponibili (LxH) / Dimensions (WxH) / Mesures (LxH)

Art. DX	Art. SX	
<b>AV08</b>	<b>AV09</b>	7,5 x 11,2

> **AB20** alimentatore (da aggiungere sempre in presenza di led)

# REED

Alluminio / Aluminium

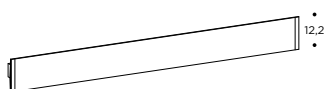

Barra Reed in alluminio bianco o nero

Reed bar in aluminum bianco or nero.

Barre Reed en aluminium bianco ou nero.

Misure disponibili (LxH) / Dimensions (WxH) / Mesures (LxH)

Art.	
<b>V332</b>	60 x 12,2
<b>V333</b>	90 x 12,2
<b>V334</b>	120 x 12,2
<b>V335</b>	150 x 12,2
<b>V336</b>	180 x 12,2
<b>V337</b>	210 x 12,2
<b>V338</b>	240 x 12,2

# REED CON FASCIA

Alluminio / Aluminium

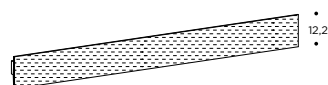

**Barra Reed in alluminio bianco o nero con fascia decorativa**

Reed bar in aluminum bianco or nero with decorative band

Barre Reed en aluminium bianco ou nero avec bande décorative

Misure disponibili (LxH) / Dimensions (WxH) / Mesures (LxH)

Art.	
<b>V692</b>	60 x 12,2
<b>V693</b>	90 x 12,2
<b>V694</b>	120 x 12,2
<b>V695</b>	150 x 12,2
<b>V696</b>	180 x 12,2
<b>V697</b>	210 x 12,2
<b>V698</b>	240 x 12,2

# ACCESSORI REED

Alluminio / Aluminium

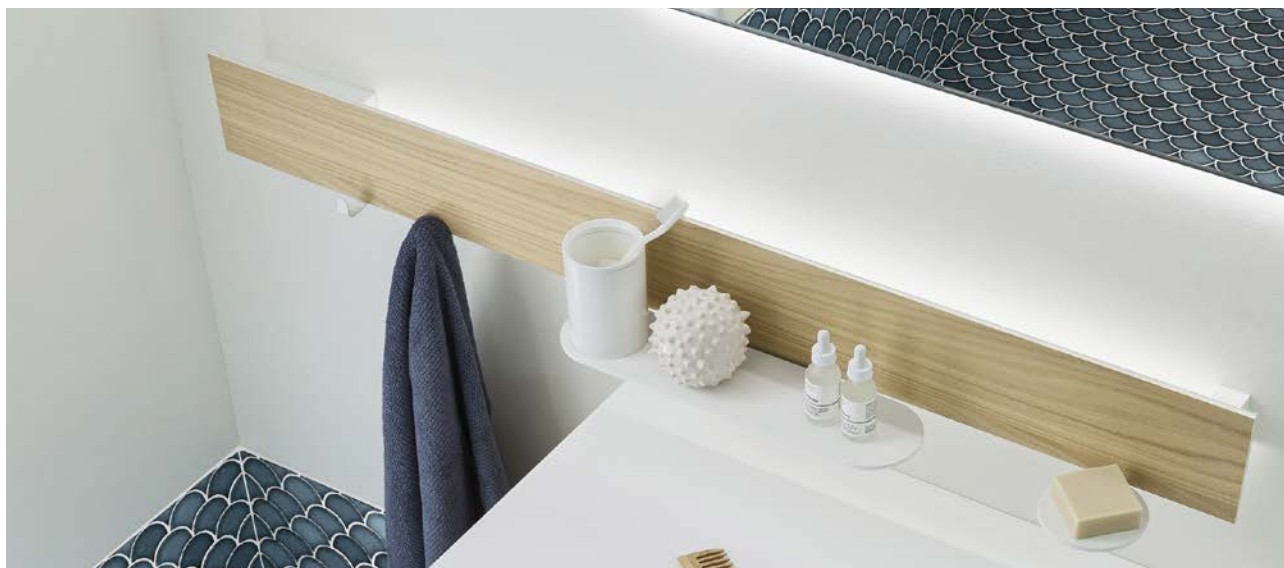

Nero  
spazz.

Bianco



**Appendino in alluminio**  
Aluminium Coat Hook  
Crochet en aluminium

> Art. **V419**

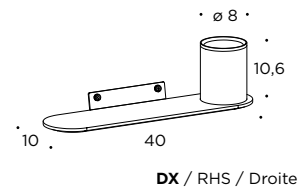

**Mensola + bicchiere dx-sx in alluminio**  
Aluminium Shelf + Glass right-left  
Étagère + Verre droite - gauche en aluminium

> Art. **V421** sx  
> Art. **V422** dx



**Portasapone in alluminio**  
Aluminium Soap Dish  
Porte-savon en aluminium

> Art. **V423**

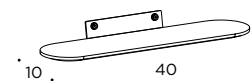
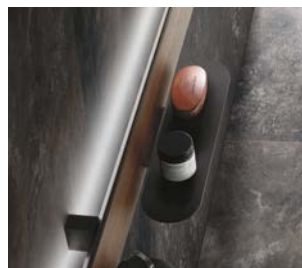

**Mensola in alluminio**  
Aluminium Shelf  
Étagère en aluminium

> Art. **V420**

# CHRONOS

Alluminio / Aluminium



- Nero spazz.
- Bianco
- Bronzo

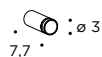

**Appendino in alluminio**  
Aluminium Coat Hook  
Crochet en aluminium

- > Art. **A782** (con inserto in finitura)
- > Art. **A783**

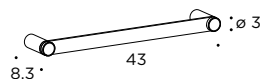

**Portasalviette L 43 in alluminio**  
Aluminium Towel rail W 43  
Porte-serviette L 43 en aluminium

- > Art. **A784** (con inserto in finitura)
- > Art. **A785**

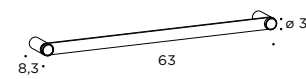

**Portasalviette L 63 in alluminio**  
Aluminium Towel rail W 63  
Porte-serviette L 63 en aluminium

- > Art. **A786** (con inserto in finitura)
- > Art. **A787**

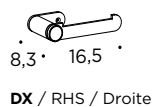

**Portarotolo dx-sx in alluminio**  
Aluminium Toilet Paper Holder right-left  
Porte-Rouleau droite - gauche en aluminium

- > Art. **A788** (con inserto in finitura)
- > Art. **A688**

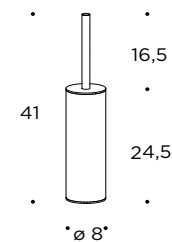

**Portascopino a terra in alluminio**  
Aluminium Floor standing toilet brush holder  
Porte-brosse WC au sol en aluminium

- > Art. **A789**

# ALMOND

Alluminio Nero / Nero Aluminium / Aluminium Nero



NEW



**Portarotolo**  
L 16,5 x H 3 x P 10 cm  
Toilet roll holder  
W 16,5 x H 3 x D 10 cm  
Porte-rouleau  
L 16,5 x H 3 x P 10 cm  
> Art. **AT45**



**Mensola L 35**  
L 35 x H 3,3 x P 18 cm  
Shelf W 35  
L 35 x H 3,3 x P 18 cm  
Étagère L 35  
L 35 x H 3,3 x P 18 cm  
> Art. **AT42**

Colore  
op. e metal

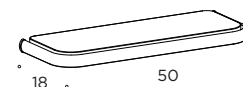
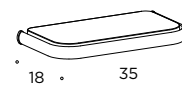

**Mensola L 50**  
L 50 x H 3,3 x P 18 cm  
Shelf W 50  
W 50 x H 3,3 x D 18 cm  
Étagère L 50  
L 50 x H 3,3 x P 18 cm  
> Art. **AT43**

# ALMOND

Alluminio Nero / Nero Aluminium / Aluminium Nero

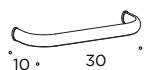

**Portasalviette L 30**  
**L 30 x H 3 x P 10 cm**  
 Towel rail W 30  
 W 30 x H 3 x D 10 cm  
 Étagère L 30  
 L 30 x H 3 x P 10 cm  
 > Art. **AT3Y**

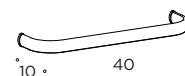

**Portasalviette L 40**  
**L 40 x H 3 x P 10 cm**  
 Towel rail W 40  
 W 40 x H 3 x D 10 cm  
 Étagère L 40  
 L 30 x H 3 x P 10 cm  
 > Art. **AT3Z**

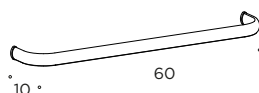

**Portasalviette L 60**  
**L 60 x H 3 x P 10 cm**  
 Towel rail W 60  
 W 60 x H 3 x D 10 cm  
 Étagère L 60  
 L 60 x H 3 x P 10 cm  
 > Art. **AT40**



**Appendino**  
**L 2,8 x H 3 x P 6 cm**  
 Towel rail  
 W 2,8 x H 3 x D 6 cm  
 Porte-manteau  
 L 2,8 x H 3 x P 6 cm  
 > Art. **AT41**

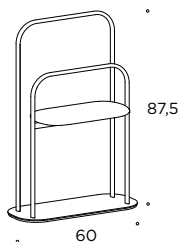

Colore  
 op. e metal

**Portasalviette a terra**  
**L 60 x H 87,5 x P 25 cm**  
 Floor standing towel rail  
 W 60 x H 87,5 x D 25 cm  
 Porte-serviette au sol  
 L 60 x H 87,5 x P 25 cm  
 > Art. **AT44**

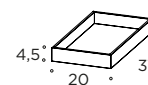

**Vassoio in CDF Rovere carbone**  
**L 20 x H 4,5 x P 37 cm**  
 Tray in CDF carbon oak  
 W 20 x H 4,5 x D 37 cm  
 Plateau en CDF chêne carbone  
 L 20 x H 4,5 x P 37 cm  
 > Art. **ACOJ**

# TOKH

Alluminio / Aluminium



# TOKH

Alluminio / Aluminium

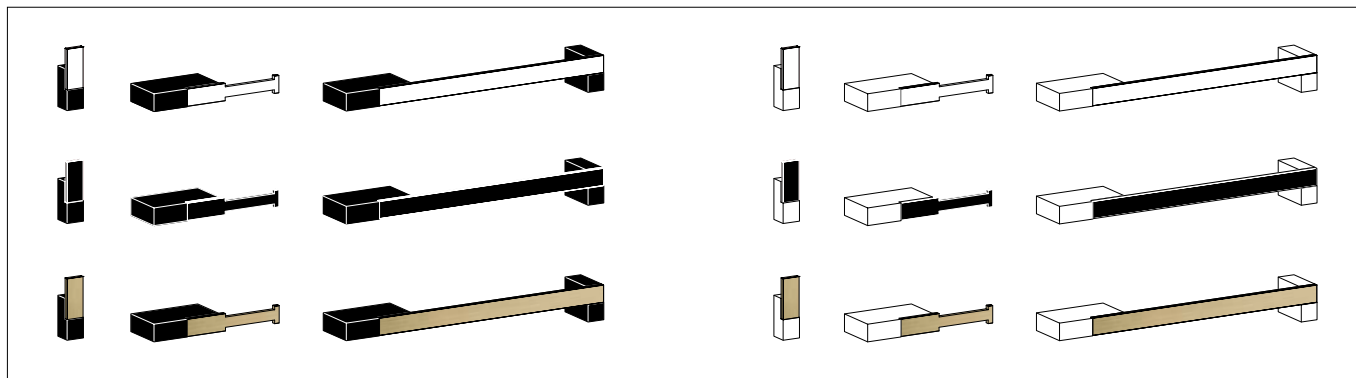

## FINITURE BARRA



## FINITURE SUPPORTI



**Portasalviette Tokh dx-sx**  
Tokh towel rail right-left  
Porte-serviettes Tokh droite-gauche

> Art. **A872** sx  
> Art. **A972** dx

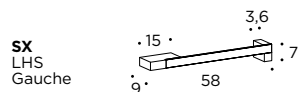

**SX**  
LHS  
Gauche

> Art. **A873** sx  
> Art. **A973** dx

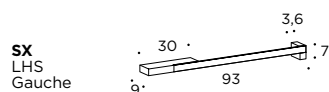

**SX**  
LHS  
Gauche

> Art. **A874** sx  
> Art. **A974** dx

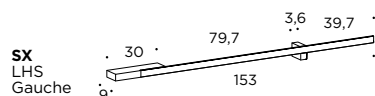

**SX**  
LHS  
Gauche

> Art. **A875** sx  
> Art. **A975** dx

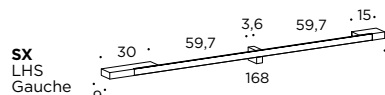

**SX**  
LHS  
Gauche



**Appendino Tokh**  
Tokh hook  
Crochet Tokh

> Art. **A870**



**Portarotolo (reversibile)**  
Tokh toilet roll holder (reversible)  
Porte-rouleau Tokh (réversible)

> Art. **A871**

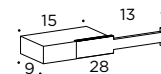

# ZEUS

Alluminio / Aluminium



Inox  
spazz.

Nero  
spazz.



**Appendino**  
Coat hook  
Porte-manteau

> Art. **A751**

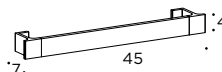

**Portasalviette L 45**  
Toewl rail W 45  
Porte-serviette L 45

> Art. **A758**

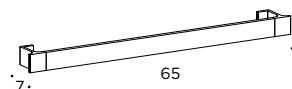

**Portasalviette L 65**  
Toewl rail W 65  
Porte-serviette L 65

> Art. **A759**

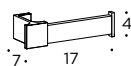

**Porta rotolo**  
Toilet roll holder (reversible)  
Porte-rouleau (réversible)

> Art. **A754**

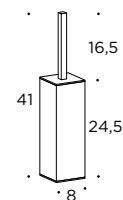

**Portascopino a terra**  
Floor standing toilet brush holder  
Porte-brosse wc au sol

> Art. **A757**

# STEP

Legno massello / Solid wood / Bois massif



**Panca in legno massello**  
Solid wood bench  
Banquette en bois massif

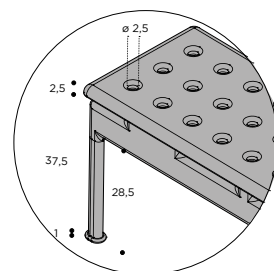
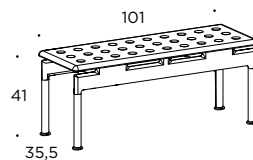

Frassino  
nero

Noce  
Canaletto

Misure disponibili (LxHxP) / Dimensions (WxHxD) / Mesures (LxHxP)

Art.	
<b>A790</b>	101 x 41 x 35,5



**Portasalviette in legno massello**  
Wooden towel rail solid wood  
Porte-serviette en bois massif

Frassino  
nero

Noce  
Canaletto

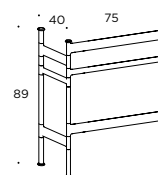

**Mansola in corian portasapone per portasalviette Step**  
Corian shelf soap holder for Step towel rail  
Étagère en corian porte-savon pour porte-serviette Step

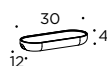

Corian

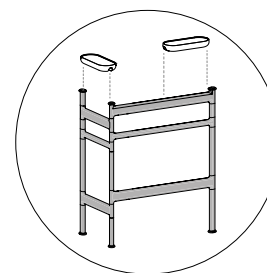

Misure disponibili (LxHxP) / Dimensions (WxHxD) / Mesures (LxHxP)

Art.	
<b>A791</b>	75 x 89 x 40

Art.	
<b>V070</b>	30 x 4 x 12

# PORTASALVIETTE

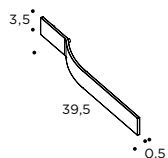

**Portasalvietta Snoopy**  
Toewl rail Snoopy  
Porte-serviette Snoopy

- > Art. **A431** (brill)
- > Art. **A297** (nero spazz.)

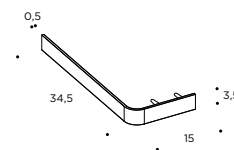

**Portasalvietta Linus**  
Toewl rail Linus  
Porte-serviette Linus

- > Art. **A432** (brill)
- > Art. **A298** (nero spazz.)

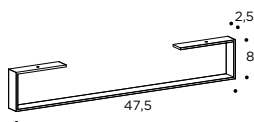

**Portasalvietta Mafalda**  
Toewl rail Mafalda  
Porte-serviette Mafalda

- > Art. **A325** (brill)
- > Art. **A299** (nero spazz.)

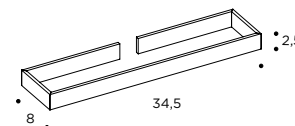

**Portasalvietta Maffy**  
Towel rail Maffy  
Porte-serviette Maffy

- > Art. **A211** (brill)
- > Art. **A300** (nero spazz.)



**Portasalvietta Fast per fianco di tamponamento curvo**  
Towel rail fast for curved infill side panel  
Porte-serviette fast pour côté de compensation curvé

- > Art. **A210** (brill)

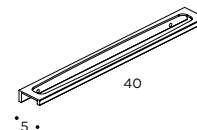
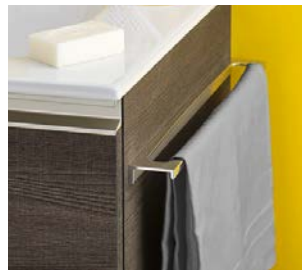

**Portasalvietta Fast**  
Aluminium towel rail  
Porte-serviette en aluminium

- > Art. **A233** (brill spazzolato)

# PORTASALVIETTE



**Portasalvietta Fast L 50 e 60**  
 Tokh towel Fast W 50 and 60  
 Porte-serviettes Fast L 50 et 60

> Art. **A205** (brill)

**Portasalvietta Fast L 70**  
 Tokh towel Fast W 70  
 Porte-serviettes Fast L 70

> Art. **A207** (brill)

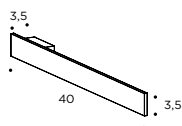

**Portasalvietta Band**  
 Tokh towel Band  
 Porte-serviettes Band

> Art. **A778** (bianco)  
 > Art. **A871** (inox spazz.)  
 > Art. **A779** (nero spazz.)  
 > Art. **AA23** (oro spazz.)  
 > Art. **AC13** (25 colori)



# ACCESSORI CON DIVISORI IN VETRO

ACCESSORIES WITH GLASS DIVIDERS

ACCESSOIRES AVEC SÉPARATIONS EN VERRE

P/D  
45-50



Per cassetti P 45 e 50 cm. Esclusi i modelli Code, Absolute, Luxor e Almond.  
Fondo in tonalità grigia, con divisori in vetro Dark Grey H 7,6 x sp. 0,8 cm

For drawers D. 45 and 50 cm. Excluding Code, Absolute, Luxor and Almond models.  
Grey bottom, with Dark Grey glass dividers H 7.6 x D 0.8 cm

Pour tiroirs P 45 et 50 cm. Sauf modèles Code, Absolute, Luxor et Almond.  
Fond en tonalité grise, avec séparateurs en verre Dark Grey H 7,6 x ép. 0,8 cm.

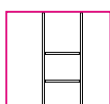

Misure disponibili (LxHxsp.) / Dimensions (WxHxth.) / Mesures (LxHxép.)

Art.	
<b>V387</b>	<b>50 x 7,6 x 0,8 cm</b>

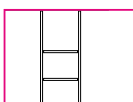

Art.	
<b>V388</b>	<b>60 x 7,6 x 0,8 cm</b>

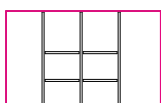

Art.	
<b>V389</b>	<b>70 x 7,6 x 0,8 cm</b>



Art.	
<b>V390</b>	<b>85 x 7,6 x 0,8 cm</b>



Art.	
<b>V391</b>	<b>95 x 7,6 x 0,8 cm</b>



Art.	
<b>V392</b>	<b>105 x 7,6 x 0,8 cm</b>



Art.	
<b>V393</b>	<b>120 x 7,6 x 0,8 cm</b>

# ACCESSORI CON DIVISORI IN VETRO

P / D  
50

ACCESSORIES WITH GLASS DIVIDERS

ACCESSOIRES AVEC SÉPARATIONS EN VERRE



Per cassetti P 50 cm. Solo per i modelli Almond, Luxor, Absolute e Code.  
Fondo in tonalità grigia, con divisori in vetro Dark Grey H 7,6 x sp. 0,8 cm

For drawers D. 50 cm. Only for Almond, Luxor, Absolute and Code models.  
Grey bottom, with Dark Grey glass dividers H 7.6 x D 0.8 cm

Pour tiroirs P 50 cm. Seulement pour les modèles Almond, Luxor, Absolute et Code.  
Fond en tonalité grise, avec séparateurs en verre Dark Grey H 7,6 x ép. 0,8 cm.

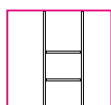

Misure disponibili (LxHxsp.) / Dimensions (WxHxth.) / Mesures (LxHxép.)

Art.	
<b>A387</b>	<b>50 x 7,6 x 0,8 cm</b>

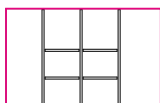

Art.	
<b>A389</b>	<b>70 x 7,6 x 0,8 cm</b>

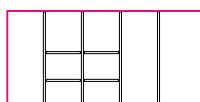

Art.	
<b>A390</b>	<b>85 x 7,6 x 0,8 cm</b>



Art.	
<b>A391</b>	<b>95 x 7,6 x 0,8 cm</b>



Art.	
<b>A392</b>	<b>105 x 7,6 x 0,8 cm</b>



Art.	
<b>A393</b>	<b>120 x 7,6 x 0,8 cm</b>

# ACCESSORI RASTER



Elementi divisori in CDF rovere carbone con bordo nero a vista.  
 Ogni set è composto dagli elementi indicati con le lettere A, B, C e D.  
 Il divisorio tipo A include un elemento in metallo porta trucchi.  
 Set per cassetti P 50 cm. Solo per i modelli Almond, Luxor, Absolute e Code

Partition elements in CDF carbon oak with visible black edge. Each set consists of the elements indicated by the letters A, B, C, and D. The type A partition includes a metal makeup holder.  
 Set for drawers D. 50 cm. Only for Almond, Luxor, Absolute and Code models

Éléments de séparation en CDF chêne carbone avec bord noir apparent. Chaque ensemble est composé des éléments indiqués par les lettres A, B, C et D. Le séparateur type A comprend un élément en métal porte maquillage.  
 Set pour tiroirs P 50 cm. Seulement pour les modèles Almond, Luxor, Absolute et Code

Per cassetti SAGOMATI / For SHAPED drawers / Pour tiroirs FAÇONNÉS

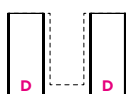

Art.	L. / W. / L.
<b>ACOU</b>	60 cm



Art.	L. / W. / L.
<b>ACOV</b>	70 cm

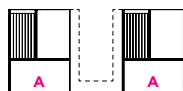

Art.	L. / W. / L.
<b>ACOW</b>	85 cm

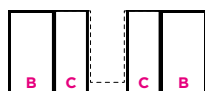

Art.	L. / W. / L.
<b>ACOX</b>	95 cm

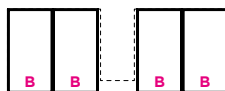

Art.	L. / W. / L.
<b>ACOY</b>	105 cm

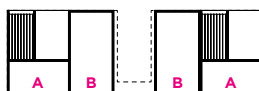

Art.	L. / W. / L.
<b>ACOZ</b>	120 cm

Per cassetti / For drawers / Pour tiroirs



Art.	L. / W. / L.
<b>ACOM</b>	35 cm

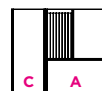

Art.	L. / W. / L.
<b>ACON</b>	50 cm

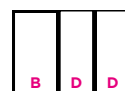

Art.	L. / W. / L.
<b>ACOO</b>	60 cm

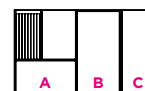

Art.	L. / W. / L.
<b>ACOB</b>	70 cm

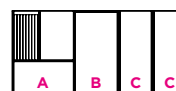

Art.	L. / W. / L.
<b>ACOG</b>	85 cm

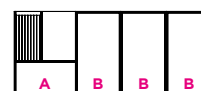

Art.	L. / W. / L.
<b>ACOA</b>	95 cm

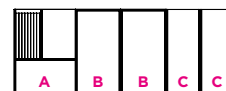

Art.	L. / W. / L.
<b>ACOS</b>	105 cm



Art.	L. / W. / L.
<b>ACOT</b>	120 cm

# ACCESSORI CON DIVISORI IN LEGNO

ACCESSORIES WITH WOOD DIVIDERS  
ACCESSOIRES AVEC SÉPARATIONS EN BOIS

P / D  
**45-50**



Per cassetti P 45 e 50 cm. Esclusi i modelli Code, Absolute, Luxor e Almond. Completo di tappetino gommato, divisori in legno H 5 cm, scatoline estraibili e vaschetta.

For drawers D. 45 and 50 cm. Excluding Code, Absolute, Luxor and Almond models. Complete with rubber mat, wooden dividers H 5 cm, removable boxes and tray.

Pour tiroirs P 45 et 50 cm. Sauf modèles Code, Absolute, Luxor et Almond. Complet avec tapis en caoutchouté, séparateurs en bois H 5 cm, petites boîtes amovibles et bac.

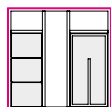

Art.	
<b>V223</b>	Set per cassetti sagomati L 50 + divisori in legno H 5 cm

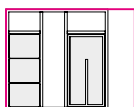

Art.	
<b>V224</b>	Set per cassetti sagomati L 60 + divisori in legno H 5 cm

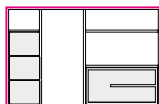

Art.	
<b>V225</b>	Set per cassetti sagomati L 70 + divisori in legno H 5 cm

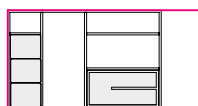

Art.	
<b>V226</b>	Set per cassetti sagomati L 85 + divisori in legno H 5 cm

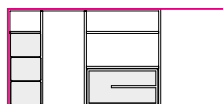

Art.	
<b>V227</b>	Set per cassetti sagomati L 95 + divisori in legno H 5 cm



Art.	
<b>V228</b>	Set per cassetti sagomati L 105 + divisori in legno H 5 cm

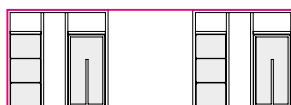

Art.	
<b>V229</b>	Set per cassetti sagomati L 120 + divisori in legno H 5 cm

ONDA  
Tekno Bianco



06.

---

# VASCHE DA BAGNO

---

BATHTUBS  
BAGNOIRES

# CLIO (freestanding)



**Vasca da bagno (con troppo pieno)**  
L 160 x P 50 x H 62 cm

Bathtub (with integrated overflow)  
W 160 x D 50 x H 62 cm

Baignoire (avec trop-plein intégré)  
L 160 x P 50 x H 62 cm

Art.	Materiali
<b>A433</b>	Mineralguss
<b>A433</b>	Tekno bianco
<b>AB04</b>	Tekno colore esterno
<b>AB03</b>	Tekno tutto colore



(colori della mazzetta esclusi metal)

(colors from the Arbi fan excluding metal)

(coloris du nuancier Arbi exclus les metal)

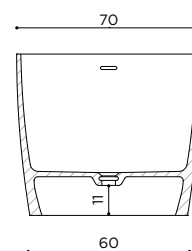
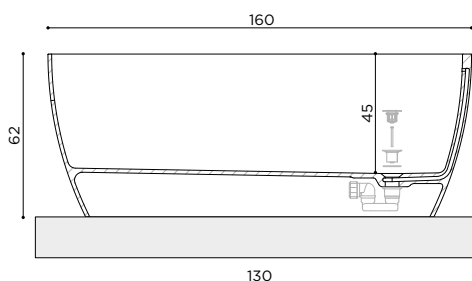
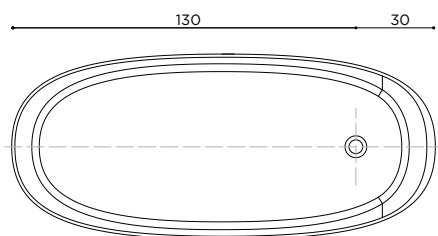

# ONDA (freestanding)



Vasca da bagno (con troppo pieno)  
L 170 x P 75 x H 55,5 cm

Bathtub (with integrated overflow)  
W 170 x D 75 x H 55,5 cm

Baignoire (avec trop-plein intégré)  
L 170 x P 75 x H 55,5 cm

Art.	Materiali
<b>R017</b>	Tekno bianco
<b>R018</b>	Tekno colore esterno
<b>R019</b>	Tekno tutto colore



(colori della mazzetta  
esclusi metal)

(colors from the Arbi  
fan excluding metal)

(coloris du nuancier  
Arbi exclus les metal)

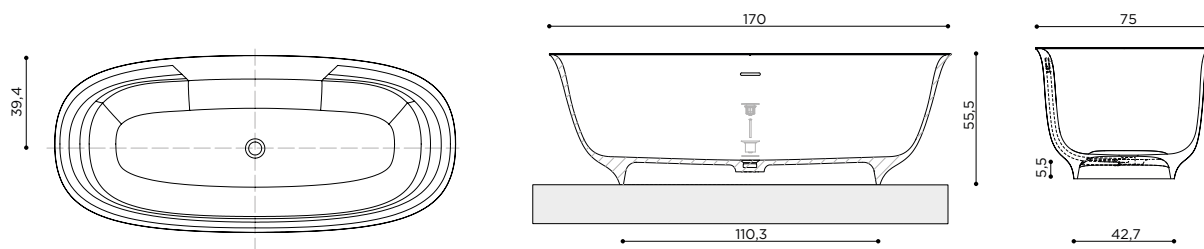

# ELSA (freestanding)



Vasca da bagno (senza troppo pieno)  
L 158 x P 77 x H 63 cm

Bathtub (without overflow)  
W 158 x D 77 x H 63cm

Baignoire (sans trop-plein)  
L 158 x P 77 x H 63 cm

Art.	Materiali
<b>A687</b>	Tekno bianco
<b>AB02</b>	Tekno colore esterno
<b>AB04</b>	Tekno tutto colore



(colori della mazzetta esclusi metal)

(colors from the Arbi fan excluding metal)

(coloris du nuancier Arbi exclus les metal)

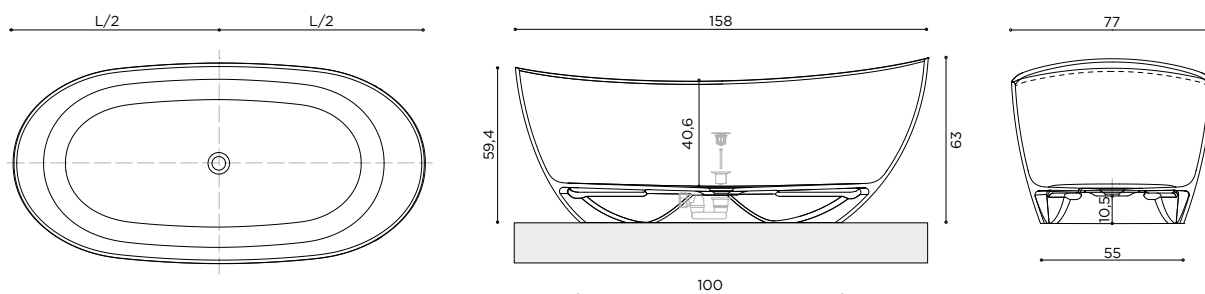

# GIULIA (freestanding)



**Vasca da bagno**  
**L 170 x P 77 x H 62 cm**  
**Mineralguss: senza troppo pieno integrato**  
**Tekno: con troppo pieno integrato**

**Bathtub**  
**W 170 x D 77 x H 62 cm**  
**Mineralguss: without integrated overflow**  
**Tekno: with integrated overflow**

**Baignoire**  
**L 170 x P 77 x H 62 cm**  
**Mineralguss : sans trop-plein intégré**  
**Tekno : avec trop-plein intégré**

Art.	Materiali
<b>A457</b>	Mineralguss
<b>A457</b>	Tekno bianco
<b>AB08</b>	Tekno colore esterno
<b>AB07</b>	Tekno tutto colore



(colori della mazzetta esclusi metal)

(colors from the Arbi fan excluding metal)

(coloris du nuancier Arbi exclus les metal)

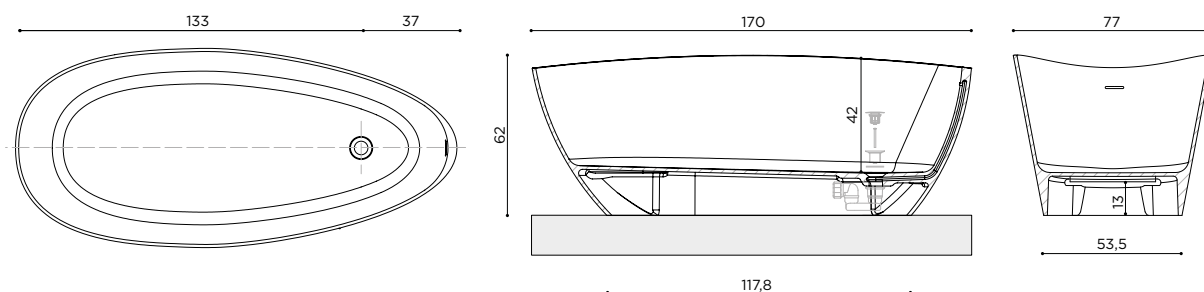

ROMAN  
Tekno Deimos



# ROMAN (freestanding)



**Vasca da bagno (senza troppo pieno)**  
L 170 x P 75 x H 60,5 cm

Bathtub (without overflow)  
W 170 x D 75 x H 60,5 cm

Baignoire (sans trop-plein)  
L 170 x P 75 x H 60,5 cm

**Mensola in Noce Canaletto per vasca Roman**

Shelf in Canaletto Walnut for Roman bathtub

Étagère en Noyer Canaletto pour baignoire Roman

Art.	Materiali
<b>A689</b>	Tekno Deimos

> Art. **V880**

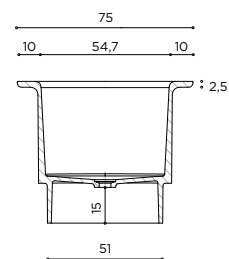
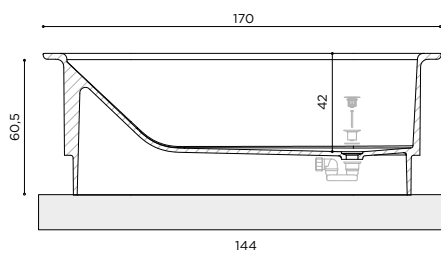
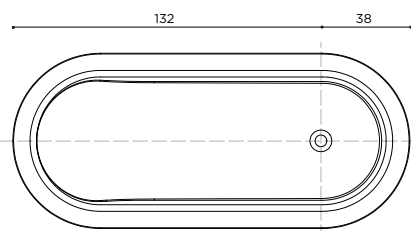
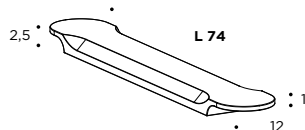

# SOLAR (freestanding)



Vasca da bagno (senza troppo pieno)  
L 160,3 x P 70 x H 57,5 cm

Bathtub (without overflow)  
W 160,3 x D 70 x H 57,5 cm

Baignoire (sans trop-plein)  
L 160,3 x P 70 x H 57,5 cm

Art.	Materiali
<b>A888</b>	Tekno bianco
<b>AB06</b>	Tekno colore esterno
<b>AB05</b>	Tekno tutto colore



(colori della mazzetta esclusi metal)

(colors from the Arbi fan excluding metal)

(coloris du nuancier Arbi exclus les metal)

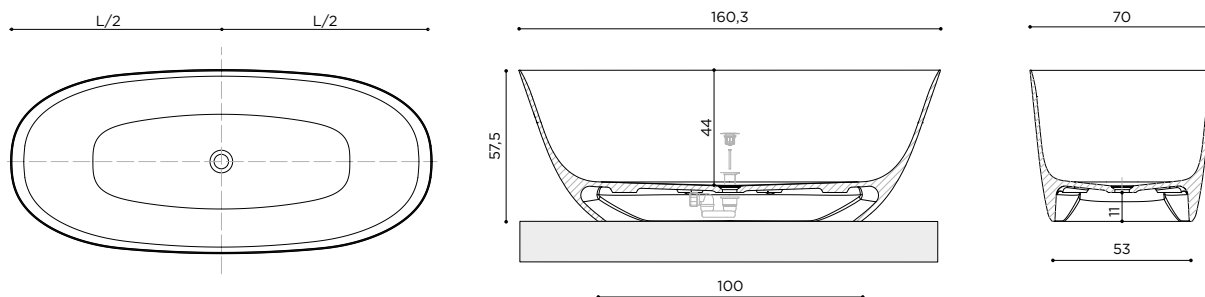

# TUB (freestanding)



Vasca da bagno (senza troppo pieno)  
L 159,3 x P 72 x H 65 cm

Bathtub (without overflow)  
W 159,3 x D 72 x H 65 cm

Baignoire (sans trop-plein)  
L 159,3 x P 72 x H 65 cm

Art.	Materiali
<b>A950</b>	Tekno bianco
<b>AB10</b>	Tekno colore esterno
<b>AB09</b>	Tekno tutto colore



(colori della mazzetta  
esclusi metal)

(colors from the Arbi  
fan excluding metal)

(coloris du nuancier  
Arbi exclus les metal)

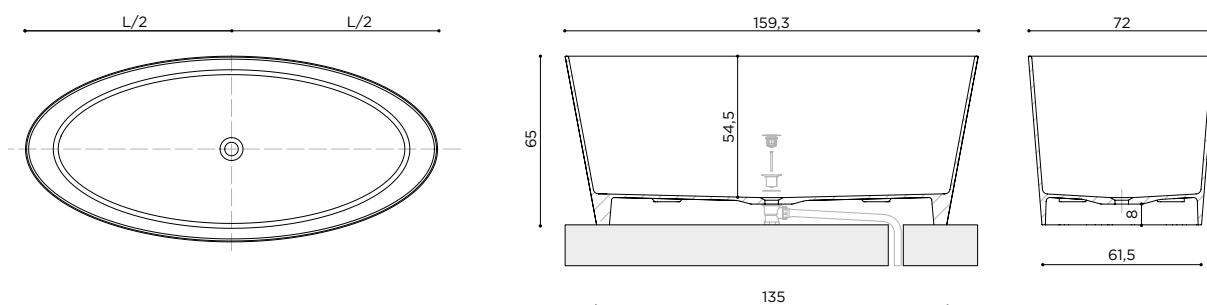

# WANDA (freestanding)



Vasca da bagno (con troppo pieno integrato)  
L 160 x P 70 x H 50,3 cm

Bathtub (with integrated overflow)  
W 160 x D 70 x H 50,3 cm

Baignoire (avec trop-plein intégré)  
L 160 x P 70 x H 50,3 cm

Art.	Materiali
<b>A692</b>	Tekno bianco
<b>A693</b>	Tekno colore esterno
<b>AB11</b>	Tekno tutto colore



(colori della mazzetta esclusi metal)

(colors from the Arbi fan excluding metal)

(coloris du nuancier Arbi exclus les metal)

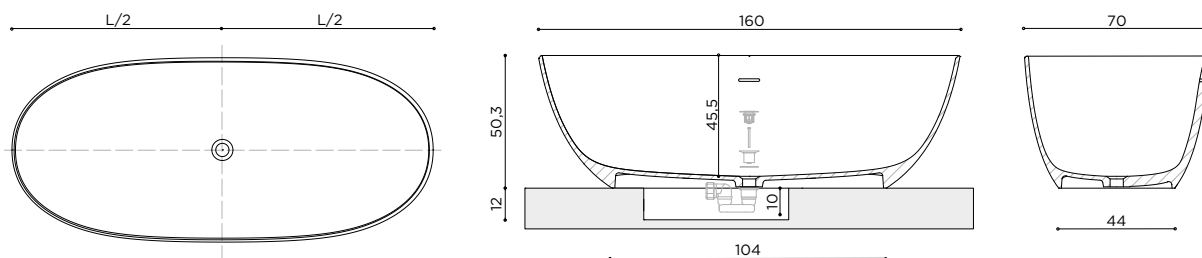

# SARA



Vasca da bagno ad angolo DX-SX  
(con troppo pieno integrato)  
L 165 x P 75 x H 50 cm

RHS-LHS corner bathtub  
(with integrated overflow)  
W 165 x D 75 x H 50 cm

Baignoire d'angle droite-gauche  
(avec trop-plein intégré)  
L 165 x P 75 x H 50 cm

Art. sx	Art. dx	Materiali
<b>ROOC</b>	<b>ROOB</b>	Tekno bianco
<b>ROOG</b>	<b>ROOD</b>	Tekno colore esterno
<b>ROOF</b>	<b>ROOE</b>	Tekno tutto colore



(colori della mazzetta  
esclusi metal)

(colors from the Arbi  
fan excluding metal)

(coloris du nuancier  
Arbi exclus les metal)

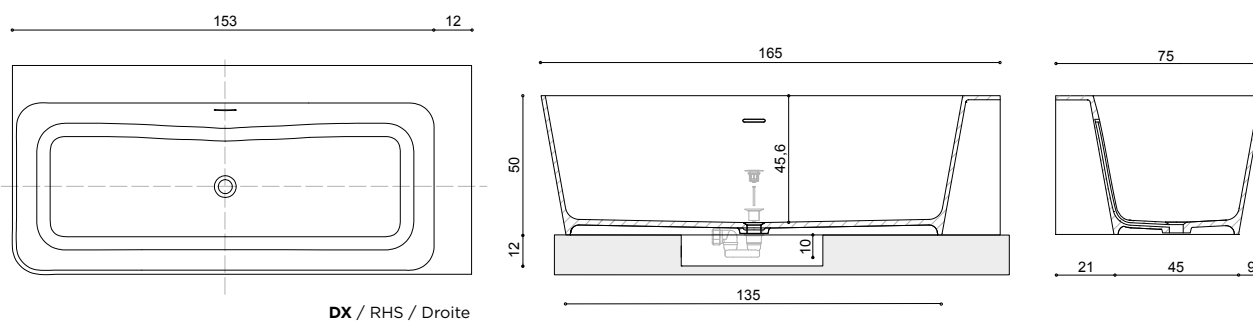

MARY  
Tekno Bianco



# MARY



Vasca da bagno a muro (con troppo pieno integrato)  
L 158 x P 86 x H 58 cm

Wall bathtub (with integrated overflow)  
W 158 x D 86 x H 58 cm

Baignoire à mur (avec trop-plein intégré)  
L 158 x P 86 x H 58 cm

Art.	Materiali
<b>A889</b>	Tekno bianco

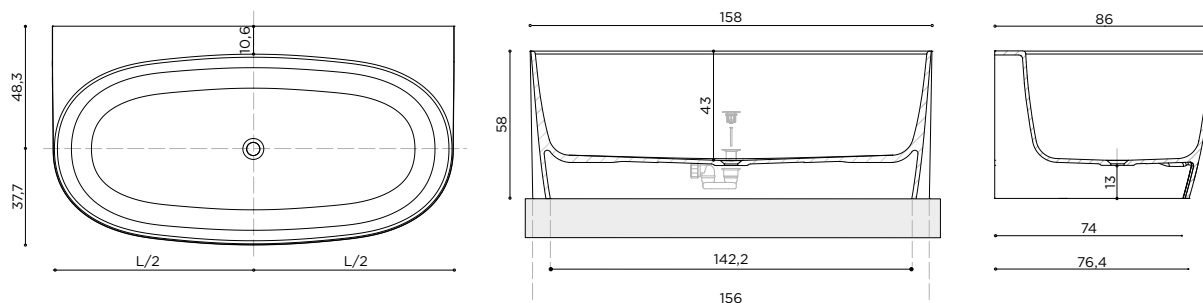

Arbi bathroom

## CREDITS

### design

Arbi Arredobagno

### graphic

Arbi Arredobagno

### images

Quattroterzi Studio

### color separation

Lucegroup.it

### print

Grafiche Antiga  
January 2026

**ARBI**  
BATHROOM

### ARBI ARREDOBAGNO SRL

Viale Lino Zanussi, 34/A  
33070, Maron di Brugnera  
Pordenone / Italy  
T. +39 0434 624822  
info@arbiarredobagno.it  
www.arbiarredobagno.it

### IBRA SHOWERS

info@ibradocce.it  
www.ibrashowers.it





**ARBI**  
BATHROOM